

GRAFEQ™

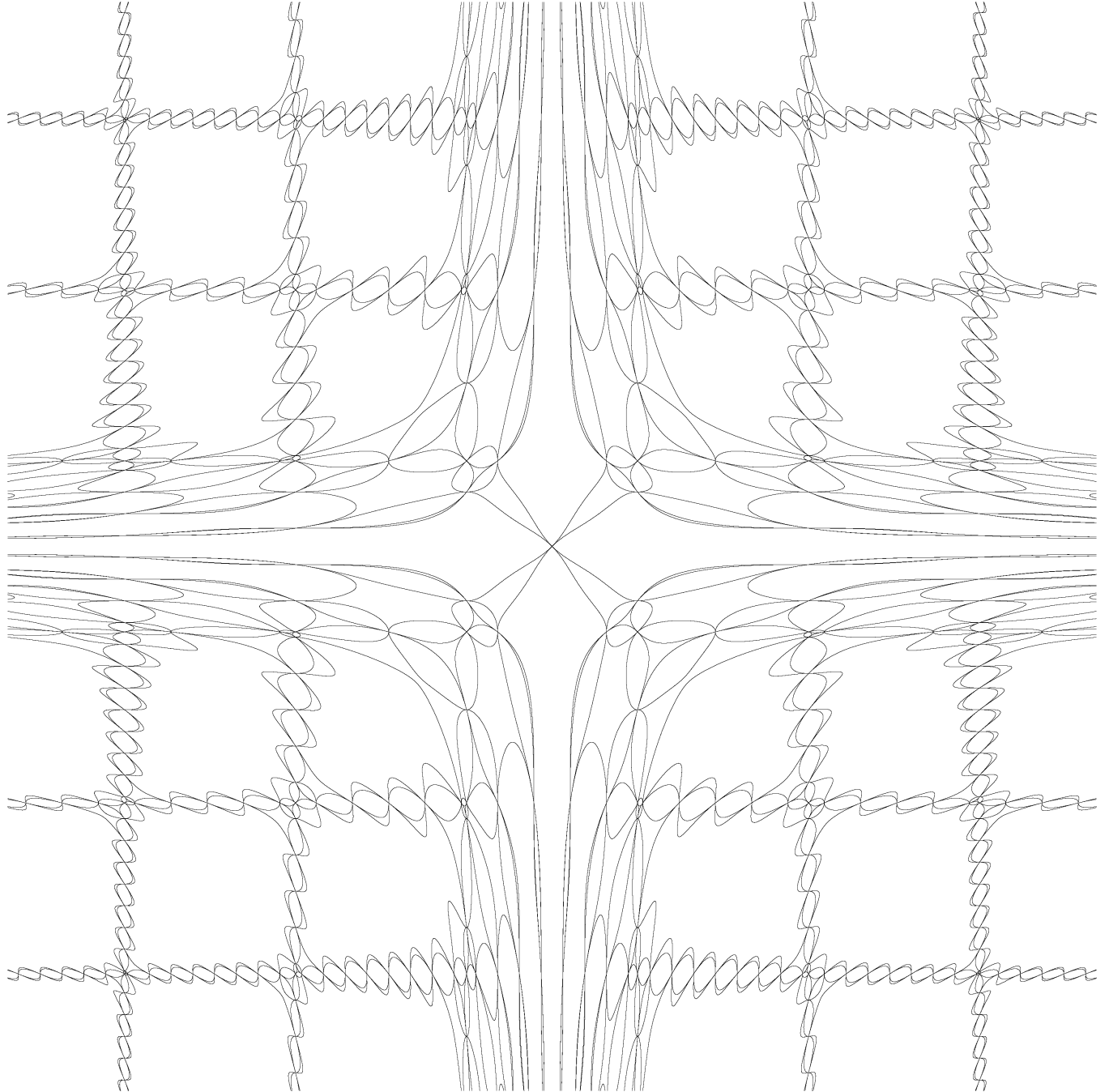

$$\frac{x}{\cos x} \pm \frac{y}{\cos y} = \frac{\pm xy}{\cos xy}$$

Pedagoguery Software

Pedagoguery Software Inc. may be contacted using any of the following addresses:

Post: Pedagoguery Software Inc.
4446 Lazelle Avenue
Terrace B.C. V8G 1R8
Canada

Telephone: +1 250 638 8606 / (250) 638-8606 (answering machine)

Fax: +1 250 638 8606 / (250) 638-8606

Email: peda@peda.com

Web: www.peda.com

Apple®, the Apple logo, ImageWriter®, LaserWriter®, and Macintosh® are registered trademarks of Apple Computer Inc. IBM® is a registered trademark of International Business Machines, Inc. MS®, Microsoft®, Windows®, and MS-DOS® are registered trademarks of Microsoft Corporation. Helvetica®, Times®, and Palatino® are registered trademarks of Linotype-Hell AG and/or its subsidiaries. GrafEq™ is a trademark of Pedagoguery Software Inc. All of the other registered trademarks used herein, and displayed by the software, are the property of their respective owners.

©Pedagoguery Software Inc. 1990, 1991, 1993, 1994, 1995, 1997, 1998, 1999, 2000, 2001.

License Agreement

This license is a **legal agreement** between Pedagogy Software Inc. and you, the licensee, either as a registered user or as an unregistered user.

Limited Warranty

If the software was provided to you on disk(s), Pedagogy Software Inc. warrants those disk(s) to be free from defects in materials and workmanship under normal use for a period of ninety (90) days from the date of delivery to you as evidenced by your proof of purchase.

Disclaimer of Warranty

Although we have thoroughly tested the software and reviewed the documentation, Pedagogy Software Inc. makes no warranties, except for the limited warranty described in the preceding paragraph, either express or implied, with respect to the software, its quality, performance, merchantability or fitness for any particular purpose.

Ownership: The software is owned by Pedagogy Software Inc..

Individual License: The licensee is entitled to use a single copy of the software on a single computer. At no time should the licensee have two (or more) copies of the program running concurrently.

Site License: The licensee is entitled to create as many copies of the software as the license permits. The software may be placed upon a network in the licensee's site provided that the total number of machines (both networked and stand alone) with simultaneous access to the software does not exceed the license. **Copies of the software shall not be made available for use outside of the licensee's site.** The licensee is also entitled to reproduce any part of any included documentation **for use within the site** or for distribution to individual student licenses. Licensees wishing to group purchase copies of the software for individual students should contact Pedagogy Software Inc.

Individual Student License: The licensee is entitled to use a single copy of the software on a single computer. At no time should the licensee have two (or more) copies of the program running concurrently.

Evaluation License: The licensee may use the software for the sole purpose of evaluating the software. After the evaluation is complete, this license expires, and the software and documentation may not be used until another license is obtained.

Other Restrictions: You may not rent or lease the software. You may not reverse engineer, decompile, or disassemble the software.

Some jurisdictions do not allow the limitation or exclusion of liability for incidental or consequential damages so portions of the above may not apply to you. In no event shall Pedagogy Software Inc.'s total liability to you for all damages, losses, and causes of action (whether in contract, tort (including negligence) or otherwise) exceed US\$50.

Care of Disk: If the software was provided to you on disk(s), they are not copy protected and you are advised to make a working copy of the disk(s) and retain the original disks(s) for archival purposes.

To use the software, you must agree to be bound by the above agreement. If you use the software, you are agreeing to be bound by the above agreement. If you do not accept this agreement, contact Pedagogy Software Inc.

Pedagogy Software Inc. welcomes correspondence from users of our software.

APPLE COMPUTER, INC. MAKES NO WARRANTIES, EITHER EXPRESS OR IMPLIED, REGARDING THE ENCLOSED COMPUTER SOFTWARE PACKAGE, ITS MERCHANTABILITY, OR ITS FITNESS FOR ANY PARTICULAR PURPOSE. THE EXCLUSION OF IMPLIED WARRANTIES IS NOT PERMITTED BY SOME STATES. THE ABOVE EXCLUSION MAY NOT APPLY TO YOU. THIS WARRANTY PROVIDES YOU WITH SPECIFIC LEGAL RIGHTS. THERE MAY BE OTHER RIGHTS THAT YOU MAY HAVE WHICH VARY FROM STATE TO STATE.

Contents

Contact Information	ii
License Agreement	iii
Contents	v
Introduction to GrafEq	1
1 The Algebraic Relation Window	3
2 The Easy Button Floating Window	7
3 The Structural Relation Window	9
4 The Create View Window	13
5 The View Window	17
6 The View Buddy Floating Window	21
6.1 Information Buddy	22
6.2 Colour Buddy	23
6.3 Ticks Buddy	24
6.4 Zoom Buddy	28
6.5 Draw Buddy	28
6.6 One Point Buddy	29
6.7 Two Point Buddy	29
7 The Custom Ticks Window	31
8 The Page Window	39
9 The Page Buddy Floating Window	41
9.1 General Draw Tools	42
9.2 Graph Tools	42
9.3 Print Tools	42
10 The Menu Bar	45
10.1 File Menu	45
10.2 Edit Menu	47

10.3	Graph Menu	48
10.4	Relation Menu	48
10.5	Custom Ticks Menu	49
11	Preferences	51
11.1	Windows Preferences	52
11.1.1	Algebraic Window Preferences	52
11.1.2	Create View Window Preferences	56
11.1.3	Custom Ticks Window Preferences	57
11.1.4	Page Window Preferences	57
11.1.5	Preferences Window Preferences	57
11.1.6	Structural Window Preference	58
11.1.7	Title Window Preference	58
11.1.8	View Window Preferences	58
11.2	Files Preferences	61
11.3	Language Preference	61
12	How GrafEq Works	63
12.1	The Algebraic Relation Parser	63
12.2	The Plotting Technique - Successive Refinement	64
12.3	Memory and Speed	66
12.4	Further Reading	67
 Appendices		
A	Easy Buttons	69
A.1	Algebra Easy Buttons	69
A.2	Arithmetic Easy Buttons	71
A.3	Basic Easy Buttons	72
A.4	Factoring Easy Buttons	73
A.5	Greek Easy Buttons	73
A.6	Integer Easy Buttons	74
A.7	Measure Easy Buttons	75
A.8	Numbers Easy Buttons	75
A.9	Order Easy Buttons	76
A.10	Relational Easy Buttons	76
A.11	Roman Easy Buttons	77
A.12	Set (and conditional definition) Easy Buttons	78
A.13	Trig Easy Buttons	79
B	Functions and Relations	83
B.1	Algebraic Functions	83
B.2	Arithmetic Operations	83
B.3	Factoring Functions	84
B.4	Integer Functions	84
B.5	Measure Functions/Magnitude Operators	84
B.6	Order Functions	84
B.7	Relational Functions	85

B.8	Set and Conditional Functions	85
B.9	Trig Functions and Relations	85
C	Draw Tools	87
C.1	The Selection Tool	87
C.2	Arrow Tools	89
C.3	Formula Tool	89
C.4	Text Tool	90
C.5	Box Tools	91
D	Values and Variables	93
D.1	Numbers	93
D.2	Roman Letters	93
D.3	Greek Letters	93
D.4	Sets	94
E	Keyboard Shortcuts	97
E.1	File Menu	97
E.2	Edit Menu	97
E.3	Graph Menu	97
E.4	Mathematics Symbols and Formats	98
E.5	View Buddy	99

Tutorials

I	A Beginner's Guided Tour	101
I.1	To launch the program	101
I.2	To enter a relation	102
I.3	To specify a viewport	103
I.4	To create a graph	103
I.5	To apply or remove axes and scales	104
I.6	To alter the viewport region by zooming	104
I.7	To edit a relation	105
I.8	To use constraints in defining a relation	107
I.9	To plot simultaneous systems	108
I.10	To blend graphs of simultaneous systems	110
I.11	To determine a point's coordinates	110
I.12	To change the colours of the graphs	110
I.13	To determine distances between points	111
II	An Enrichment Exercise	113
II.1	Plot the sine function and the McLaurin polynomial simultaneously	113
II.2	Add more terms to the McLaurin series	115
II.3	Find the error of approximation	116
	Index	122

Introduction to GrafEq

GrafEq (“GrafEq” has the same pronunciation as “graphic”) is designed for two kinds of mathematicians: the teacher and the student. Teachers will appreciate features such as the variable font size and the ability to cut and paste expressions and graphs to text documents; students will appreciate the standard mathematics notation and ease of use of the program. Everyone will appreciate GrafEq’s mathematical prowess with its broad range of relations that can be displayed with confidence.

GrafEq is an exceptional tool for exploring mathematics. As an introduction, here are some characteristics underlying the design of GrafEq:

- **Mathematical**

Algebraic specifications are accepted in a broad variety of intuitive formats. For instance, a linear equation can be entered in the form $y = mx + b$, $\frac{y-k}{x-l} = m$, or $ax + by + c = 0$.

- **Honest**

Any inaccuracy is explicitly revealed. For instance, although a pixel is very small, it is still an area rather than a point; therefore, the ‘coordinates’ of a pixel are reported using a range of values, such as $(5.210 \pm 0.002, 17.001 \pm 0.002)$.

- **Valid**

Graphs plotted are correctly. For instance, the graph of $y \leq \sqrt{16 - x^2}$ differs from the graph of $y \not\leq \sqrt{16 - x^2}$, because ‘ \leq ’ is not equivalent to ‘ $\not\leq$ ’.

- **Reliable**

No solutions will be missed: A pixel is off only if it contains no solutions at all; it stays on if it may possibly contain one or more solutions for the graph’s active relations. Extraneous solutions are eliminated when graphing is complete. The program can even use multiple colours to distinguish the pixels that have been proven to contain solutions, the pixels that have been proven to not contain solutions, and the pixels that are currently undecided.

Hint: A closed and open version of a relation will often have identical graphs on the computer’s monitor. For example: the graph of $x < 5$ will be identical to that of $x \leq 5$ unless the edge $x = 5$ falls right between two adjacent pixels.

- **Multi-faceted**

Each GrafEq graph can be presented in four forms:

- Symbolic - an algebraic definition, typeset using mathematics notation, and presented in one or more algebraic relation windows. (Each relation can contain one or more constraints, and each constraint can be an equation, an inequality, a set description, or a conditional definition.)
- Structural - a flow chart, or tree interpretation, presented in one or more structural relation windows. (Each relation is associated with an algebraic window and a structural window.)

- Graphical - a cartesian or polar representation, presented in one or more view windows.
- Printed - physical copies can be printed directly from GrafEq by means of its page editing window, or indirectly from other programs such as word processors or drawing applications by first copying the relations and/or graph views from GrafEq, and then pasting into the other program.

This manual provides a convenient and complete reference to the various features and some anticipated application of such features. Various tutorials, from beginner to expert levels, are also useful tools and a starting point for a rewarding journey of mathematics exploration.

Hint: This manual presumes that the reader will have access to general information about the computer and its operating system, as well as mathematical terminology and concepts.

If the illustrations in this manual do not match your display, check your preference settings. The screen shots are from a computer running Windows 98.

GrafEq will run on a black and white display, in which case some references to colours should instead be references to patterns.

Chapter 1

The Algebraic Relation Window

The algebraic relation window is for entering the algebraic specification of a relation. One appears automatically at startup, after the title screen is removed. More can be brought up by selecting *New Relation* from the *Graph* menu. Figure 1.1 shows a blank algebraic relation window:

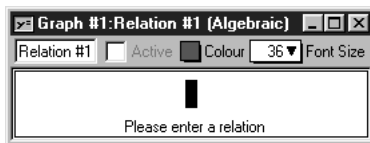

Figure 1.1: *A blank algebraic relation window*

The algebraic relation window consists of the following elements:

- a title bar,
- a parameter bar, and
- some constraint fields.

In addition, an easy button floating window is available for help in relation entry. Easy buttons are especially useful when entering symbols not readily available from the standard keys on a keyboard, such as π , or any powers. For details, refer to the Easy Button Floating Window chapter (page 7).

The elements of the algebraic relation window are explained as follows:

Hint: An algebraic window’s title bar, parameter bar, and relation constraints are synchronized with, or equivalent to, their structural relation window counterparts. Custom ticks windows have the same setup for title and parameter bars. Therefore, the corresponding manual sections are equivalent.

Title bar The title bar displays the graph title and the relation title followed by the “(Algebraic)” label, which distinguishes it from the title bar of the structural relation window. Relation title can be changed using the parameter bar’s title edit box. Figure 1.2 shows the title bar:



Figure 1.2: *The title bar of an algebraic window*

Parameter bar The parameter bar is for customizing the relation title, starting and stopping graphing, modifying the graph colour, and changing the font size used to display constraints within the algebraic relation window. Figure 1.3 shows the parameter bar:



Figure 1.3: *The parameter bar of an algebraic window*

The elements, from left to right, are explained as follows:

Title edit box The title edit box is for changing the relation’s title. Custom titles are useful in demonstrations and for print-outs. The default title, “Relation #1”, is easily changed: click on the title edit box to start editing. The new title will replace the old one in all menus, windows, and buttons that show the relation’s title.

Active checkbox The *Active* checkbox is for starting and stopping relation plotting in open graph view windows. Clicking on the checkbox, or the checkbox name, toggles between the selected and unselected states. Deselecting the checkbox halts graph plotting and hides the relation from all graph views. Selecting the checkbox resumes graph plotting from where it left off and shows the relation in all graph views.

Hint: The *Active* checkbox is greyed out and unavailable if any constraint of the relation is invalid.

Colour pop-up menu The *Colour* pop-up menu is for changing the colour used for the relation in graph views. This control is useful for optimizing the clarity of graph views. The colour can be changed by clicking on the *Colour* box to access the pop-up colour menu, and then selecting the desired colour from the menu. For black-and-white graphs, a *Pattern* pop-up menu replaces the *Colour* pop-up menu. Colour computers can display black-and-white graphs. For more information, refer to the colour buddy section of the View Buddy Floating Window chapter (page 21).

Font Size pop-up menu The *Font Size* pop-up menu is for changing the font size used to display relation constraints in the relation window. This control is useful for presentations via an overhead liquid crystal display (LCD) or a large screen television. The font size can be changed by clicking on the *Font Size* pop-up menu to bring up a menu of available font sizes, and then selecting the desired size from the menu. All constraints of the current algebraic relation window will be displayed in the selected font size.

Hint: Some options in the algebraic relation window’s parameter bar do not change the behaviour or the appearance within the algebraic window itself.

- The *Active* checkbox affects the behaviour (graphing) of graph view windows.
- The *Colour* pop-up menu affects the appearance (graph colour) of graph view windows.

Constraint fields Constraint fields are for entering relation constraints. The constraints entered are displayed in standard mathematics format, which is desirable when including relations in handouts or documents (by copying relations from GrafEq and pasting them into a word processor). The formatted presentation also gives some visual feedback that constraints are interpreted as intended. Figure 1.4 shows a sample relation with two constraints (in two constraint fields):

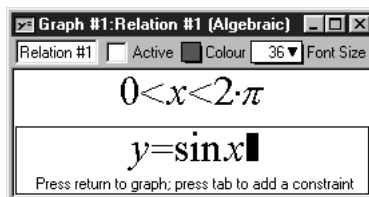

Figure 1.4: *An algebraic window with two constraint fields*

While a constraint is being entered or changed,

- prompts appear at the bottom of the constraint field, and the easy button floating window is available to offer support for the specification process;
- a blinking cursor is present;
- the *Active* checkbox of the algebraic window is unselected, and greyed out unless all constraints of the relation are valid;
- press the Tab key to move to the next constraint, or to create a new one if there is not a next constraint;
- press the Tab key while holding down the Shift key to move to the previous constraint, or to create a new one if there is not a previous constraint.

When functions are entered using multiple characters, the characters are unformatted, and presented in red, until GrafEq recognizes them as a function name: red signifies unrecognized entries. GrafEq can interpret “sin” as the sine function, instead of the product “ $s \times i \times n$ ”, only after an argument, such as x , is entered. A good example is the square root function, when entered as “sqrt”: GrafEq will replace the letters with a graphical radical symbol after an argument is started.

Hint: If the cursor is positioned away from the end of the relation string during editing, all characters to the right side of the cursor become unformatted. With the default preference settings, unformatted characters are shown in solid red on colour displays, while they are outlined in black (not filled in) on black-and-white displays.

Tip: The “Symbol” and “Times” TrueType fonts must be installed in order to produce attractive screen output, unless the font settings have been changed in the preferences.

Tip: More information on the format and structure of constraints and the parser is available in the How GrafEq Works chapter (page 63).

Conclusion

To conclude this chapter of the manual, here are some additional hints and tips about the algebraic relation window:

- Each algebraic relation window describes one relation; the relation can be defined using a single constraint or multiple constraints. Additional constraint fields can be brought up by pressing the Tab key from within the algebraic relation window.
- Each graph can have one or more relations. Each relation is described in one algebraic window, and is normally assigned a colour different from that of the other relations. Additional algebraic windows can be opened by selecting *New Relation* from the *Graph* menu. Relations from the same graph are plotted on the same views, using the same coordinate system.
- New graphs can be opened by selecting *New Graph* from the *File* menu. When a new graph is opened, a new algebraic relation window appears automatically. The default graph title is “Graph # k ”, where k is a new sequence number. Different graphs are unrelated; to view multiple relations in the same window, multiple relations are created within one graph.

- Besides the algebraic window, each relation may be presented using a tree structure in a structural relation window. Corresponding algebraic and structural windows are synchronized, so common attributes describing the relation can be changed in either window, and are reflected in both. Examples of common attributes include the relation title, graphing activity, and relation colour. The tree structure representation in the structural relation window is a new feature introduced in GrafEq 2.04. For details, see the Structural Relation Window chapter (page 9).
- The keystrokes field is a strip beneath the current constraint field. It shows the keystrokes used to produce the formatted relation in the constraint field. Keystroke information is especially useful when the intuitive mathematics symbols and notation have no obvious correspondence with the keys on a keyboard. Figure 1.5 shows a sample keystrokes field with its corresponding constraint field:

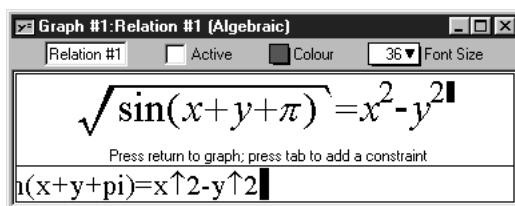

Figure 1.5: An algebraic window with its keystroke field

Prior to version 2.04, GrafEq always provided this information via the keystroke field. But as of GrafEq 2.04, keystroke information can be revealed within the constraint entry fields by positioning the cursor to the left of the entries. The keystroke field is hidden using the default preferences, although it is still available and remains useful for printing purposes. To display the keystrokes field, change the preferences.

- A relation entry can be completed by selecting the *Active* box of its algebraic window or by pressing the enter key. When relation entries are completed, the algebraic window will collapse to display just the title bar, parameter bar, and constraint fields - prompts, the blinking cursor, the keystroke field, and the easy button floating window will disappear. The *Active* checkbox will be selected, but it can be freely deselected and selected without editing any constraints.
- Clicking within any constraint field of a completed algebraic window will return you to the edit mode and remove the relation from any opened graph views.

Chapter 2

The Easy Button Floating Window

The easy button floating window provides buttons that assist you in entering relations. Easy buttons are especially useful when entering symbols not readily available from the keys on a standard keyboard. The easy button floating window automatically appears when a relation, or custom ticks, or any expression definition is being edited. It can be shown, or hidden, by selecting *Easy Buttons* from a *Relation* menu or a *Custom Ticks* menu.

Buttons within the floating window are organized into groups, based on common usage: related symbols and operations are contained within each group. These groups are presented in alphabetical order. Figure 2.1 shows the easy button floating window displaying group headings, with only the *Basic* group of easy buttons expanded to reveal the individual easy buttons:

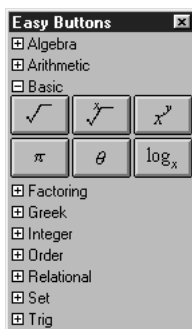

Figure 2.1: *The default easy button floating window*

Details about the easy buttons are explained in Appendix A, the Easy Buttons appendix (page 69). Following are some notes about the floating window:

- The easy button floating window appears when a relation, or custom ticks, or any expression definition is being edited. It is otherwise hidden, but returns once a relation or a custom ticks definition is being edited.

Hint: The easy button floating window disappears when relation or expression editing is completed, or when a new window or program is activated.

- Each group of easy buttons can be expanded, to display its easy buttons below its title, or collapsed, to display just its title, by clicking on the name of the group, or the hierarchy box beside the name.
- Groups can be removed from, or added to, the easy button floating window by changing the preference settings, as follows:

1. From the *File* menu, select *Preferences*;
2. expand *Algebraic Window*;
3. expand *Easy Buttons*;
4. expand *Access*; then
5. select the desired groups' checkboxes under the *Available* column to add those groups; deselect the undesired groups' checkboxes to remove those groups.

Hint: If a group's checkbox is not selected under the *Available* column, the buttons of that group will not be accessible at all. By default, the *Measure*, *Numbers*, and *Roman* groups are not available; all of the other groups are available.

To have an available group automatically expand at startup, like the *Basic* group does by default, select the group's checkbox in the *Expand on Startup* column.

Expanding and collapsing available groups is often done, during a session, by clicking on the name of the corresponding group, or on the hierarchy box beside the name.

- To automatically keep the easy button floating window hidden while editing relations, change the preferences as follows:
 1. From the *File* menu, select *Preferences*;
 2. expand *Algebraic Window*;
 3. expand *Easy Buttons*; then
 4. deselect the *Show easy buttons* checkbox.
- To hide the easy button floating window during a session, click on the window's close box, or deselect *Easy Buttons* from a *Relation* menu or a *Custom Ticks* menu.

Chapter 3

The Structural Relation Window

The structural relation window is a new feature introduced in GrafEq 2.04. It displays a flow chart (a treelike, structural representation) for a relation. The window can be brought up by selecting *Relation #k (Structure)* from the *Graph* menu, or selecting *Structural Window* from a *Relation* menu. The structural window is helpful for understanding, and confirming, operator precedence within a relation. Figure 3.1 shows a structural relation window displaying the relation $y=\sin x$:

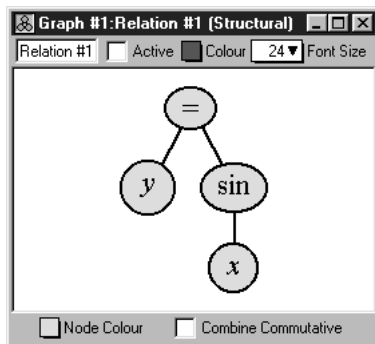

Figure 3.1: A structural relation window displaying $y=\sin x$

The structural relation window consists of the following elements:

- a title bar,
- a parameter bar,
- a tree structure field, and
- a tree control bar.

The elements of the structural relation window are explained as follows:

Hint: A structural relation window's title bar, parameter bar, and its relation description are synchronized with, or equivalent to, their algebraic relation window counterparts. Custom ticks windows have the same setup for title and parameter bars. Therefore, the corresponding manual sections are equivalent.

Title bar The title bar displays the graph title and the relation title followed by the “(Structural)” label, which distinguishes it from the title bar of the algebraic relation window. The relation title can be changed using the parameter bar's title edit box. Figure 3.2 shows the title bar:



Figure 3.2: *The title bar of a structural relation window*

Parameter bar The parameter bar is for customizing the relation title, starting and stopping graphing, modifying the relation colour, and changing the font size used to display elements of the structural representation. Figure 3.3 shows the parameter bar:



Figure 3.3: *The parameter bar of a structural relation window*

The elements, from left to right, are explained as follows:

Title edit box The title edit box is for changing the relation’s title. Custom titles are useful in demonstrations and for print-outs. The default title, “Relation #1”, is easily changed: click on the title edit box to start editing. The new title will replace the old one in all menus, windows, and buttons that show the relation’s title.

Active checkbox As with the *Active* checkbox in the algebraic window parameter bar, the structural relation window’s *Active* checkbox is for starting and stopping relation plotting in open graph view windows. Clicking on the checkbox, or the checkbox name, toggles between the selected and unselected states. Deselecting the checkbox halts graph plotting and hides the relation from all graph views. Selecting the checkbox resumes graph plotting from where it left off and shows the relation in all graph views.

Hint: The *Active* checkbox is greyed out and unavailable if any constraint of the relation is invalid.

Colour pop-up menu The *Colour* pop-up menu is for changing the colour used for the relation in graph views. This control is useful for optimizing the clarity of graph views. The colour can be changed by clicking on the *Colour* box to access the pop-up colour menu, and then selecting the desired colour from the menu. For black-and-white graphs, a *Pattern* pop-up menu replaces the *Colour* pop-up menu. Colour computers can display black-and-white graphs. For more information, refer to the colour buddy section of the View Buddy Floating Window chapter (page 21).

Font Size pop-up menu The *Font Size* pop-up menu is for changing the font size used in the tree nodes. This control is useful for presentations via an overhead liquid crystal display (LCD) or large screen television. The font size can be changed by clicking on the *Font Size* pop-up menu to bring up a list of available font sizes, and then selecting a new size from the menu.

Hint: The font size of the structural relation window affects the tree structure field, while the font size of the algebraic window affects the constraint fields. However, the title edit box, *Active* checkbox, and *Colour* pop-up menu of corresponding structural and algebraic relation windows are identical, and are synchronized. Changes in one will be reflected in the other.

Some controls in the structural relation window’s parameter bar do not change the behaviour or the appearance within the structural window itself.

- The *Active* checkbox affects the behaviour (graphing) of graph view windows.
- The *Colour* pop-up menu affects the appearance (graph colour) of graph view windows.

Tree structure field The tree structure field displays a relation using a tree structure. The tree structure is updated as the relation is entered. Figure 3.4 shows the sequence of tree structures displayed as the relation $y=\sin x$ is entered:

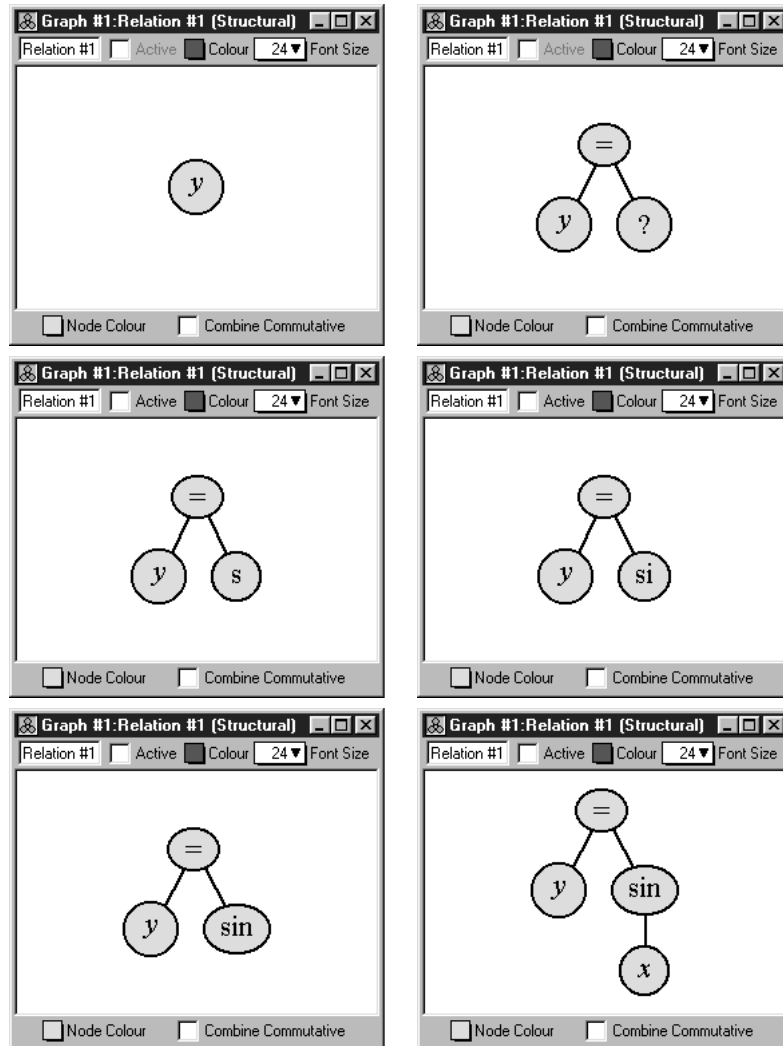

Figure 3.4: The sequence of tree structures displayed as $y=\sin x$ is entered

Tree control bar The tree control bar is for customizing general attributes of the tree structure field, including node colour and tree structure format. Figure 3.5 shows the tree control bar:



Figure 3.5: The tree control bar of a structural relation window

The elements, from left to right, are explained as follows:

Node Colour pop-up menu The node *Colour* pop-up menu is for changing the colour used to display tree nodes in the structural window. This control is useful for optimizing the clarity of the displayed tree structure. The colour can be changed by first clicking on the colour pop-up to bring up the pop-up colour menu, and then selecting the desired colour from the menu.

Combine Commutative checkbox The *Combine Commutative* option is for combining commutative operations within the tree structure. Clicking on the checkbox toggles between its selected and unselected states.

Figure 3.6 shows two tree structures for the same relation: The one the left, with the *Combine Commutative* unselected, shows a full, binary tree structure. The one on the right, with the *Combine Commutative* selected, shows a flatter tree structure, with commutative operations combined together.

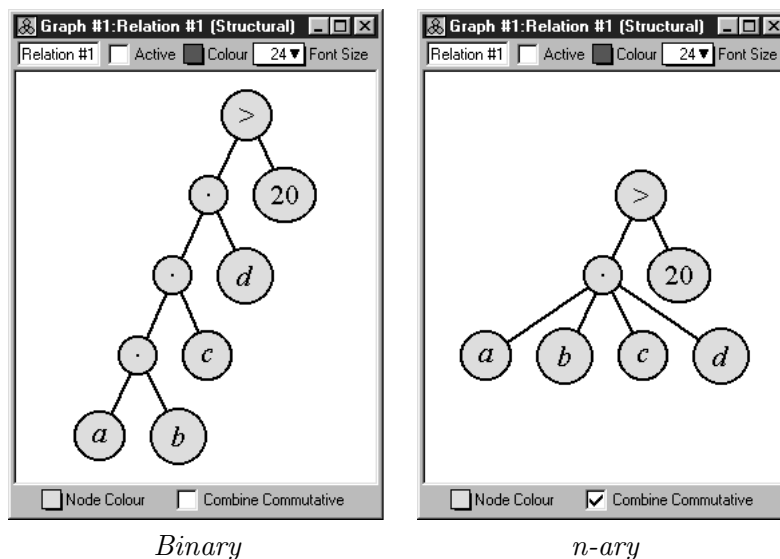

Figure 3.6: *Alternative tree structure presentations*

Conclusion

To conclude this chapter of the manual, following are some additional hints and tips about the structural relation window:

- Each structural relation window describes one relation; the relation can consist of a single constraint, or have multiple constraints. Constraints are linked together using an “and” operation.
- A structural window can be brought up by selecting *Relation #n (Structure)* from the *Graph* menu.
- Each structural relation window is associated with an algebraic window, and both describe the same relation. Corresponding structural and algebraic windows are synchronized, so common attributes describing the relation can be changed in either window, and are reflected in both. Common attributes include the relation title, graphing activity, and relation colour. For details about the algebraic window, see the Algebraic Relation Window chapter (page 3).
- A relation’s structural window, algebraic window, and easy button floating window can be shown or hidden by selecting or deselecting the appropriate option from a *Relation* menu. A *Relation* menu appears only when an algebraic or structural relation window is foremost.

Chapter 4

The Create View Window

The create view window is for specifying attributes for the new view window to be created. Example attributes are graph type (cartesian or polar), and view scope (variables and bounds). The create view window can be brought up by selecting *New View* from the *Graph* menu. It also appears automatically if the current graph does not have any views open, and a relation specification is completed by pressing the enter key.

The create view window comes in two modes; a cartesian mode and a polar mode, as shown in figure 4.1:

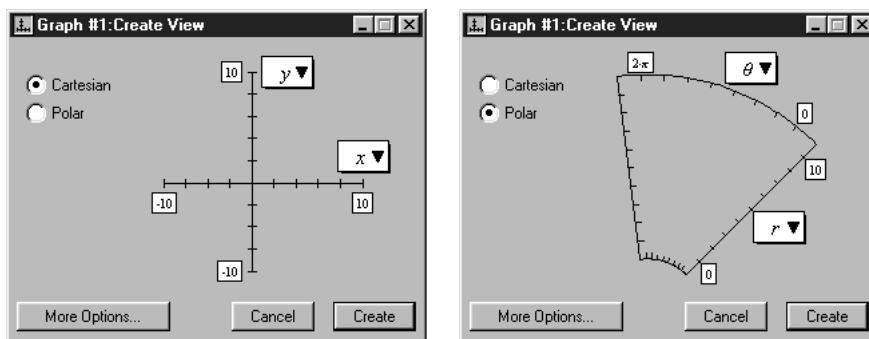

Cartesian mode

Polar mode

Figure 4.1: *Two create view windows*

The create view window contains the following elements:

- two graph radio buttons,
- a domain and a range pop-up menu,
- four bound edit boxes,
- a *Cancel* button,
- a *Create* button, and
- a *More Options...* button.

The elements of the create view window are explained as follows:

Cartesian and Polar radio buttons The *Cartesian* and *Polar* radio buttons are for changing the coordinate system used for plotting. They are in the upper left area of the create view window. GrafEq sets the mode to *Polar* only if r or θ are the variables in the constraint specification; otherwise, GrafEq sets the mode to *Cartesian*. The mode can be changed by clicking on the other radio button or on its name.

Hint: If x and/or y , as well as r and/or θ , is used in a relation specification, GrafEq sets the mode to *Cartesian*.

Domain and range pop-up menus A variable pop-up menu is adjacent to each of the domain and range axes. They are for specifying the variables used for each axis of the new view. In the *Cartesian* mode, the variables default to x and y ; in the *Polar* mode, they default to r and θ . For a graph specified in variables other than x and y , or r and θ , the variables can be changed by clicking on the respective pop-up menu to bring up the menu of available variables, and then selecting a new variable from the menu.

Bound edit boxes Two sets of upper and lower bound edit boxes are adjacent to each of the domain and range variable axes. They are for specifying the bounds of the graph. In *Cartesian* mode, the default bounds are -10 to 10 for both x and y ; in *Polar* mode, the default bounds are 0 to 10 for r , and 0 to 6.28 for θ . Any of the bounds can be changed by first clicking inside their respective edit boxes, and then editing the bounds. Bounds can be simple numbers, or numeric expressions.

Hint: When variable bounds are being edited, an easy button floating window is available for help in expression entry. Easy buttons are especially useful when entering symbols not readily available from the standard keys on a keyboard, such as π , or any powers. For details, refer to the Easy Button Floating Window chapter (page 7).

Hint: Instead of the mouse, the Tab key or the arrow keys can be used to move among the edit boxes.

Create button The *Create* button is in the center left area of the create view window, and is for closing the create view window and opening the specified new view window.

Hint: Plotting of all active relations of the current graph will commence in the new view in the new window unless automatic graphing is turned off in the option or preference settings.

Cancel button The *Cancel* button is for aborting the creation of a new graph view. It is right below the *Create* button. Clicking on it will simply close the create view window without creating a new view.

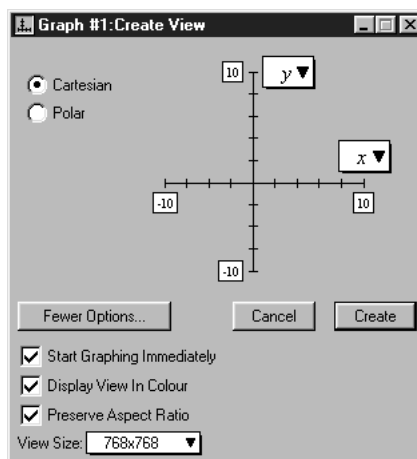

Figure 4.2: *Create view window*

More Options... button The *More Options...* button is in the bottom center of the create view window. Click it; the additional options will be displayed, and the *More Options...* button will become a *Fewer Options...* button.

The additional view creation options are explained as follows:

Start Graphing Immediately checkbox The *Start Graphing Immediately* checkbox is for controlling whether or not GrafEq starts plotting immediately and automatically after the graph view is created. If the option is unselected, GrafEq waits until the *Graph* checkbox in the view window's parameter bar is selected to start plotting, which might be desired during explanation or presentations. Clicking on the checkbox toggles between the selected and unselected states.

Display View in Colour checkbox The *Display View in Colour* checkbox is for choosing between a colour view or a black-and-white view. The black and white option is useful for printing to a black-and-white printer. Clicking on the checkbox toggles between the selected and unselected states.

Hint: The black and white option is also useful for exporting to another application, such as a word processor, for further processing and subsequent black-and-white printing.

Preserve Aspect Ratio checkbox The *Preserve Aspect Ratio* option is for setting the aspect ratio fixed at one. If the option is deselected, aspect ratio depends on the variable bounds.

View Size pop-up menu The *View Size* pop-up menu is for changing the size of the graph view on the monitor. GrafEq determines the default view size according to the size of the monitor used. The default size can be changed by clicking on the *View Size* pop-up to bring up a menu of available sizes, and then select a size from the menu.

Hint: View dimensions are measured in pixels. For high resolution display or printouts, select large values from the *View Size* pop-up menu to achieve best results.

Conclusion

To conclude this chapter of the manual, following is an additional hint about the create view window:

- If the create view window is brought up by pressing the enter key from an algebraic relation window, the relation specification is completed: the algebraic window collapses to display just the title bar, parameter bar and constraint field(s) - prompts, the blinking cursor, the keystrokes field, and the easy button floating window will all disappear.

Chapter 5

The View Window

The view window is for displaying, and investigating, graphs of relations. GrafEq produces graphs using an iterative process: a rough approximation to the graph is first presented, which is then refined over time. Eventually, a correctly plotted graph of all active relations will be displayed. For more information about the plotting process, see the How GrafEq Works chapter (page 63).

A view window can be created by pressing the *Create* button of the create view window.

Hint: The create view window appears automatically if a relation specification is completed by pressing the enter key and the current graph does not have any open views. It can also be brought up by selecting *New View* from the *Graph* menu; additional views can be opened this way.

Figure 5.1 shows a view window displaying a graph with one active relation, $y=\sin x$:

Hint: Initial settings are adopted from the create view window.

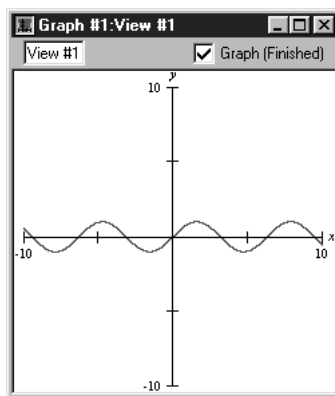

Figure 5.1: A view window displaying a graph with one active relation, $y=\sin x$

The view window consists of the following elements:

- a title bar,
- a parameter bar, and
- a view region.

The elements of the view window are explained as follows:

Title bar The title bar displays the graph title and the view title. The view title can be changed using the parameter bar's title edit box. Figure 5.2 shows the title bar:



Figure 5.2: *The title bar of a view window*

Parameter bar The parameter bar is for customizing the view title, showing graphing status, controlling graphing activity, and displaying the percentage of the graphing area that has been proven to be correct. Figure 5.3 shows the parameter bar:



Figure 5.3: *The parameter bar of a view window*

The elements, from left to right, are explained as follows:

Title edit box The title edit box is for changing the view’s title. Custom titles are useful in demonstrations and for print-outs. The default title, “View #1”, is easily changed: click on the title edit box to start editing. The new title will replace the old one in all menus, windows, and buttons that show the view’s title.

Graphing barber pole The graphing barber pole relays graphing activity. It revolves while the graph is being plotted. It is replaced with a blank bar if graphing is stopped, but not completed. It disappears when graphing has been completed: an absent bar means that the displayed graph has been proven to be correct in every detail.

Graph (...) checkbox The *Graph (...)* checkbox lets you pause, and resume, graphing. Graphing occurs when the checkbox is selected: clicking on the checkbox toggles between the selected and unselected states.

A progress report is shown in brackets; explanations of the common progress reports follow.

- “Waiting” means that graphing has not started.
- “> p % Proven”, with a single relation, means that more than p percent of the displayed pixels have been proven to be correctly coloured. With multiple relations, the average of the amounts proven for each relation is under-reported. For example, with two relations, one finished and the other just begun, the progress report would be “>49.9% Proven”.
- “Finished” means that graphing has completed.

The following explains the reports that are shown when graphing cannot continue.

- “Memory Stall” means that there is not enough available memory for graphing to continue. Increasing the amount of memory available to GrafEq may help.
- “Subdivisions Exhausted” means that even though the remaining (uncertain) pixels have been divided into the finest mesh GrafEq can use, no more proofs were forthcoming. Changing the syntactic form of the relation or zooming into the region of interest may help.
- “Precision Exhausted” means that GrafEq’s underlying number system does not have enough precision for graphing to progress. A correct graph of the desired area may be possible by introducing scaling and/or translation transformations into the relation.

Hint: If the *Graph* checkbox is deselected after graphing has finished, no change will occur.

View region The view region is the main part of the view window: it displays the current view of the graph. Figure 5.4 shows a sequence of view windows displaying progressive stages of graph plotting, finishing with the completed plot.

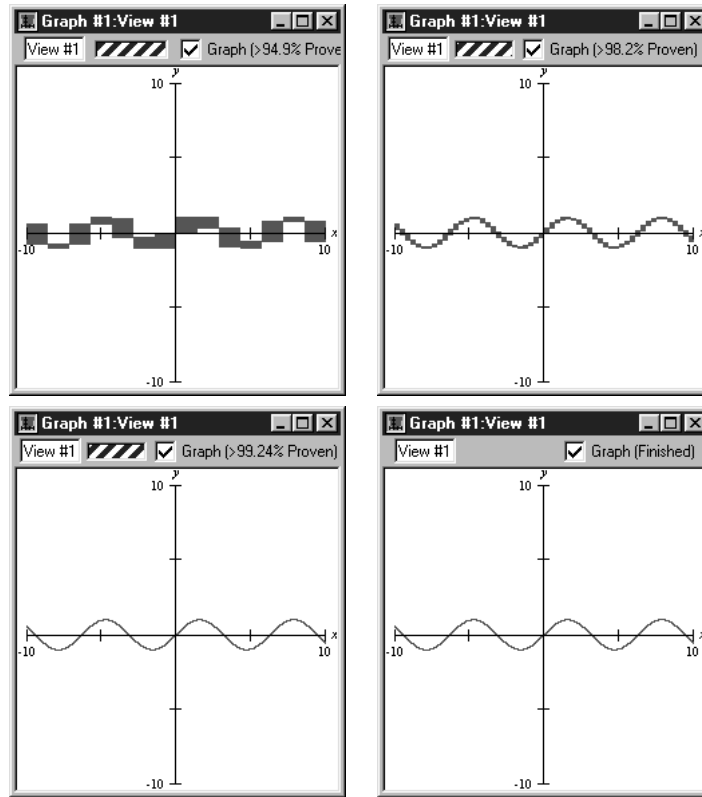

Figure 5.4: *Progressive stages of graph plotting*

Hint: Ticked axes are applied to the view according to the current preference settings. They can be customized across sessions by modifying the preference settings, which are accessed by selecting *Preferences* under the *File* menu. The ticked axes can be turned off, for the current view window only, by deselecting *Ticks* in the colour view buddy. More controls over the ticked axes are available in the ticks view buddy. The ticks view buddy has many controls besides those for turning ticks on and off. Refer to the View Buddy Floating Window chapter (page 21) for details.

Following is a summary of the controls of, and the various attributes of, the view window and its view region:

- The choice of the coordinate system used (cartesian or polar), the axes variables, and the initial view bounds (view scope) are made in the create view dialog box.
- A graph view's on-screen dimensions are set in the view options dialog box.
- The choice between a colour graph and a black-and-white graph is made in the view options dialog box. This choice can be changed by using the colour view buddy.

Hint: The colour view buddy has many controls besides simply turning colour display on and off. Refer to the View Buddy Floating Window chapter (page 21) for details.

- Each view window has a view buddy floating window, which appears automatically when a graph window is foremost. The view buddy provides tools for interpreting and augmenting a graph and its views. Refer to the View Buddy Floating Window chapter (page 21) for details.

Conclusion

To conclude this chapter of the manual, following are some additional hints and tips about the view window:

- Each view window displays one view of a graph.

Hint: A graph can include one or more relations; a relation can be described by one or more constraints.

A graph can have multiple views. Each view shows all active relations of the graph within its specified view scope, using the options chosen for that view. Multiple views are useful for comparing different graphs, or for comparing different regions of the same graph.

- Additional views can be created by selecting *New View* from the *Graph* menu. The desired display may be obtained by customizing the options in the create view dialog box (and possibly the view options dialog box).

Chapter 6

The View Buddy Floating Window

The view buddy floating window provides tools for interpreting and augmenting a graph and its views. It appears automatically when a view window is foremost. Figure 6.1 shows the view buddy window in its initial mode, *Colour*:

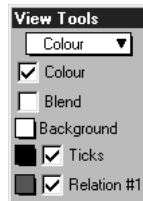

Figure 6.1: *The view buddy floating window in its initial mode, Colour*

The view buddy has seven different modes: *Colour* mode is the initial mode, and is shown in figure 6.1 earlier; the other modes are accessible by clicking on the mode pop-up menu, and then selecting a new mode from the menu that pops up.

The mode pop-up menu is at the very top of the view buddy floating window, and includes:

- *Information* mode,
- *Colour* mode,
- *Ticks* mode,
- *Zoom* mode,
- *Draw* mode,
- *One Point* mode, and
- *Two Point* mode.

Before going into details about the different modes of the view buddy, following are some hints about the floating window and its modes:

- The view buddy floating window appears only when a view window is foremost. It is otherwise hidden, but returns when a view window is activated.
- Options in the *Information*, *Ticks*, *Draw*, *One Point*, and *Two Point* modes apply only to the one view window directly associated with the view buddy. Options in the *Colour* and *Zoom* mode apply to all view windows of the associated graph.

- And following are some general use instructions:
 - Selecting an option's checkbox activates the option; clicking on a checkbox or its name toggles between its selected and unselected states;
 - Clicking on a pop-up menu opens the pop-up list or table, so the desired option can be selected from it.
 - The *Colour* mode is the initial mode since its options are most generally useful for optimizing the clarity and readability of graph views.

6.1 Information Buddy

The *Information* buddy displays advanced, technical data about the graphing process. It is accessed by selecting *Information* from the buddy mode pop-up menu at the top of the floating window. Figure 6.2 shows the information buddy displaying data for the graph view as a whole:

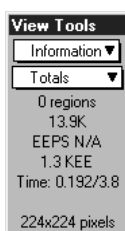

Figure 6.2: *The Information buddy displaying data for the graph view as a whole*

The information buddy has several different sub-modes. *Totals* sub-mode is the default, as seen in figure 6.2 earlier. It displays data for the graph as a whole. Other modes display data for an individual relation of the graph. Each mode is accessed using the sub-mode pop-up menu, which is just below the mode pop-up menu at the top of the view buddy floating window

All information displayed applies to the immediately associated graph view only. The data elements, from top to bottom, are explained as follows:

Number of regions Number of regions shows the number of rectangular blocks remaining to be refined by GrafEq. When plotting is completed, it will be zero.

Hint: The number of regions often can increase early in the graphing process as GrafEq splits up the view region into more rectangular regions, then decrease as GrafEq verify more regions as satisfying or not satisfying the relations.

Memory allocated Memory allocated shows the RAM being used by the graph. It reflects the complexity of the graph and the plotting technique employed. When plotting is completed, it shows the RAM required for displaying the plotted graph in the view window.

Evaluation speed Evaluation speed shows the up-to-the-moment average rate of graph processing. It reflects the complexity of the graph relations, processor speed, and memory resources. Evaluation speed is measured in Equation Evaluations Per Second (EEPS), Kilo EEPS (KEEPS), or Mega EEPS (MEEPS). When graphing is completed, this rate will be removed from the display.

Total number of evaluations Total number of evaluations shows the up-to-the-moment total of evaluations performed by the graphing process. It varies with the complexity of the graph view. The number of evaluations is measured in Equation Evaluations (EE), Kilo EE (KEE), or Mega EE (MEE). When graphing is completed, this number will stop changing.

CPU time/total time CPU time shows the amount of time the CPU has spent on graphing after factoring out the time spent on other tasks. Total time shows the total amount of time that has elapsed since graphing started. Any time that elapsed while the graphing process was deactivated (by deselecting the *Graph (...)* checkbox) is excluded in the CPU time and total time measurements.

Tip: If CPU time is small relative to total time, closing non-essential windows and/or quitting other programs will increase graphing speed, as GrafEq will be able to use more CPU time for graphing.

Dimensionality Dimensionality shows the dimension refining is occurring in. Even though GrafEq presents graphs using two dimensional views, GrafEq may be processing relations in higher dimensions if relations include variables other than the axes variables.

View size View size shows the view region's width and height, in pixels. It is available only in the *Totals* sub-mode.

Show Work checkbox and colour pop-up menus *Show Work* and its colour options are for displaying plotting processes. They are available in each individual relation sub-mode, but not the *Totals* sub-mode. When *Show Work* is selected, the view region would be coloured as follows:

- pixels that are proven to contain solutions have the appropriate relation's colour;
- pixels that are proven to not contain solutions have the background's colour; and
- pixels not yet proven to contain, or not to contain, solutions, have the work area colour(s).

Two colour pop-up menus are provided for the work area, which will flash between the two selected colours. If the same colour is selected for both pop-up menus, work areas will appear in the one colour, and will not flash. Flashing is useful when using a black-and-white display.

Background colour pop-up menu The *Background* colour pop-up menu is for conveniently changing the graph's background colour. It is useful for making work areas stand out.

Hint: A background colour pop-up menu is also in the *Colour* buddy (which is explained in the next section). The two pop-up menus are synchronized.

The contents of the information view buddy can be customized using the preferences. For details, refer to the Preferences chapter (page 51).

6.2 Colour Buddy

The *Colour* buddy is for changing the appearance of graph views. It is accessed by selecting *Colour* from the buddy mode pop-up menu at the top of the floating window. Figure 6.3 shows the colour mode view buddy:

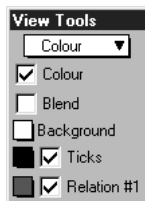
Figure 6.3: *The Colour buddy*

All colour view buddy options apply to *all* view windows of the associated graph. The elements, from top to bottom in the colour buddy, are explained as follows:

Colour checkbox The *Colour* checkbox is for toggling between a colour view and a black-and-white view. The black and white option is useful for printing to a black-and-white printer.

Blend checkbox The *Blend* checkbox is for toggling between blending and layering colours when a graph displays multiple relations which have intersecting regions. Blended graphs show off intersecting areas clearly. In a layered graph, GrafEq initially displays relations in the order that their respective relation windows are opened, earliest at the bottom, latest at the front. The layers can be reordered by hiding and redisplaying relations. Deselect a relation to hide it; re-select it to display that relation at the front. Clicking on the relation's checkbox toggles between its selected and unselected states.

Background colour pop-up menu The *Background* colour pop-up menu is for changing the colour used for the graph's background. For black-and-white graphs, the background colour can be either solid black or solid white.

Ticks pop-up menu and checkbox The *Ticks* colour pop-up menu is for changing the colour used for the ticks. For black-and-white graphs, the ticks can be either black or white. The checkbox adjacent to the colour pop-up menu is for showing and hiding the ticks.

(optional) Custom ticks colour pop-up menus and checkboxes Each custom ticks pop-up menu and checkbox is similar to the ticks pop-up menu and checkbox, but control display options for custom ticks instead of ticks.

Hint: Custom ticks colour pop-up menus are synchronized with the pop-up menus in the custom ticks windows.

(one or more) Relation colour pop-up menus and checkboxes Relation colour pop-up menus are for changing the colours used to display relations. For black-and-white graphs, patterns are chosen instead of colours; a pattern pop-up menu is available instead of a colour pop-up menu. The checkboxes adjacent to the colour pop-up menus are for showing and hiding relations.

Hint: Relation colour (or pattern) pop-up menus are synchronized with the colour (or pattern) pop-up menus in algebraic and structural relation windows.

6.3 Ticks Buddy

The *Ticks* buddy is for showing or hiding the ticks, selecting optional tick components, and customizing the appearance of the ticks. It is accessed by selecting *Ticks* from the buddy mode pop-up menu at the top part of the floating window. Figure 6.4 shows the ticks mode view buddy presenting the *Preconfigured* ticks options:

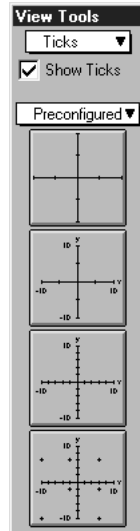

Figure 6.4: *The Ticks buddy presenting the Preconfigured ticks*

All options apply to the current view only.

The *Show Ticks* checkbox is the first option offered in the ticks buddy: it is just below the mode pop-up menu. When the checkbox is selected, ticks are shown.

Tip: By default preference settings, ticks are shown automatically when new views are opened. If GrafEq doesn't show ticks, graphing of complex relations might be faster. For details about changing preference settings, refer to the Preferences chapter (page 51).

The ticks buddy provides four different ticks sub-modes. *Preconfigured* is the default sub-mode, as seen in figure 6.4 earlier. Other sub-modes include *Marks*, *Outline*, and *Parameters*. Each sub-mode is accessed using the pop-up menu below the *Show Ticks* checkbox.

The ticks sub-modes are explained as follows:

Preconfigured The *Preconfigured* sub-mode provides basic (simplified) tick options using four buttons. Each button sets the ticks to a preconfigured setting, as follows:

- button 1: axes and sparse ticks;
- button 2: axes, sparse ticks, axes labels, and bounds;
- button 3: axes, dense ticks, axes labels, and bounds;
- button 4: axes, dense ticks, axes labels, and bounds, and grid cross ticks.

Tip: This option can be used for making graph paper.

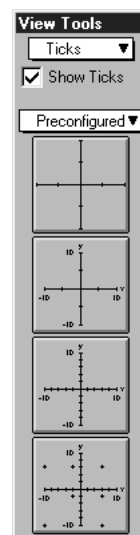

Figure 6.5: *The Preconfigured sub-mode of the ticks buddy*

Marks, outline, and parameters These sub-modes are for controlling the composition and appearance of the ticks. Options are offered using expandable lists, which have the following properties:

- Lists can be toggled between an expanded and a collapsed state, by clicking on the list's title or on the adjacent hierarchy box.
- Expanded lists reveal their elements and/or sub-lists. Revealed list elements can then be selected, or deselected individually; and sub-lists can then be further expanded, or collapsed. The same rules that apply to lists also apply to sub-lists.
- Some lists also come with checkboxes adjacent to their respective boxes. The list box can be checked or unchecked to conveniently, and collectively, select or deselect *all* element options covered by the list.
A list which has selected as well as unselected elements displays a horizontal bar in its checkbox.
- Expanded lists can be collapsed by clicking on the list's title, or on the adjacent hierarchy box.

Marks The *Marks* sub-mode is for selecting which tick components are shown. The various marks are useful for interpreting the graph, and for augmenting its display. Figure 6.6 shows marks options:

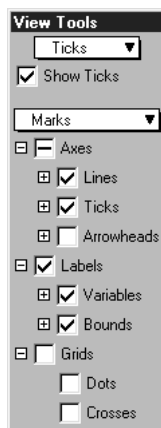

Figure 6.6: *The Marks sub-mode of the ticks buddy*

- **Axes** checkbox, and list which is expandable to the following:
 - *Lines* checkbox, and list which is expandable to *Domain* and *Range* checkboxes. Select these options to display the axis lines.
 - *Ticks* checkbox, and list which is expandable to *Domain* and *Range* checkboxes. Select these options to display the ticks on axis lines at the selected density.
 - *Arrowheads* checkbox, and list which is expandable to *Domain* and *Range* checkboxes, and lists of which each is further expandable to *Min* and *Max* checkboxes. Select these options to display the arrowhead appearances.
- **Labels** checkbox, and list which is expandable to the following:
 - *Variables* checkbox, and list which is expandable to *Domain* and *Range* checkboxes. Select these options to display the variable labels.
 - *Bounds* checkbox, and list which is expandable to *Domain* and *Range* checkboxes, and lists of which each is further expandable to *Min* and *Max* checkboxes. Select these options to display the bound values.
- **Grids** checkbox, and list which is expandable to *Dots* and *Crosses* checkboxes. Select these options to display dots and crosses to cover the entire graph view.

Outline The *Outline* sub-mode is for setting the thickness of the optional outline around tick components. A small area (an outline) may be placed around tick components, which can improve readability, especially in cluttered graphs. Figure 6.7 shows outline options:

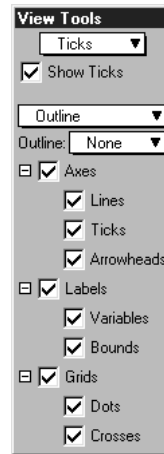

Figure 6.7: *The Outline sub-mode of the ticks buddy*

- *Outline...* thickness pop-up menu
- *Axes* checkbox, and list which is expandable to *Lines*, *Ticks* and *Arrowheads* checkboxes. Select these options to stand-out the axis lines, ticks and/or arrowheads.
- *Labels* checkbox, and list which is expandable to *Variables* and *Bounds* checkboxes. Select these options to stand-out the variable labels, and/or bound labels.
- *Grids* checkbox, and list which is expandable to *Dots* and *Crosses* checkboxes. Select these options to stand-out the dots, and/or crosses.

Parameters The *Parameter* sub-mode is for changing the font size used for tick labels, the density of tick marks used, the tick size, and for choosing marginal or in-line axes. Figure 6.8 shows parameters options:

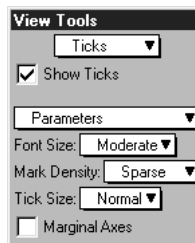

Figure 6.8: *The Parameters sub-mode of the ticks buddy*

- The *Font Size* pop-up menu is for changing the font size for any displayed variables and bound labels included in the ticks. The presence, or absence, of elements is governed by the *Marks* sub-mode.
- The *Mark Density* pop-up menu is for changing the density of ticks, dots, and crosses. The presence, or absence, of elements is governed by the *Marks* sub-mode.
- The *Tick Size* pop-up menu is for changing the size of any displayed ticks and arrowheads. The presence or absence of elements is governed by the *Marks* sub-mode.
- The *Marginal Axes* checkbox is for choosing between marginal and in-line axes. Marginal axes always lie off to the side of a graph view, while in-line axes may lie within a graph view.

6.4 Zoom Buddy

The *Zoom* buddy is for zooming in and out of a graph. It is accessed by selecting *Zoom* from the buddy mode pop-up menu at the top part of the floating window. Figure 6.9 shows a typical zoom mode view buddy:

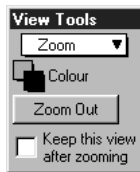

Figure 6.9: A typical *Zoom* buddy

All zoom buddy settings are shared between *all* view windows. The controls, from top to bottom in the zoom buddy, are explained as follows:

Colour pop-up menus These are a pair of colour pop-up menus: the one on the upper left is for changing the colour used for the inside the zoom box; the one on the lower right is for changing the colour used for the outline of the zoom box.

Zoom Out button The *Zoom Out* button is for zooming out from the current graph view. The new view will have the same center, but both the domain and the range will be doubled; the new view will therefore cover four times the area of the original view.

Keep Current View checkbox The *Keep Current View* checkbox is for specifying whether the current view is kept or discarded after a new view is created by zooming in or out. Select the option to compare graph views before and after zooming; deselect it to save memory and keep the machines's desktop clean and tidy.

Zoom-in box The zoom-in box specifies the scope of the new view that GrafEq will zoom into. It appears automatically when the mouse is within the graph view region. Zooming in is done by clicking the mouse, or by pressing the enter key, while the area of interest is within the zoom-in box. The size of the zoom-in box, and thus the scope it specifies, can be changed by using the arrow keys: the left arrow narrows it, while the right arrow widens it; the up arrow heightens it, while the down arrow shortens it.

Hint: The mouse is usually at the center of the zoom-in box. When the mouse is still within the view region but far out towards one side, the zoom-in box stays within the current view region by sticking to an edge. As mentioned earlier, the colours of the zoom-in box are controlled by the colour pop-up menus at the top part of the zoom buddy.

Tip: If the desired graph region is not shown in a current view because of inappropriate view bounds, or because of zooming in, they can be recovered by zooming out until the desired region is again within the view scope. Specific regions may then be examined by zooming back in.

6.5 Draw Buddy

The *Draw* buddy is for accessing drawing tools which are useful for augmenting the display of graph views. It is accessed by selecting *Draw* from the buddy mode pop-up menu on the top part of the floating window. Figure 6.10 shows the draw mode view buddy:

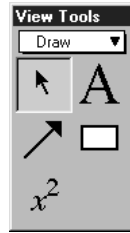
Figure 6.10: *The Draw buddy*

All drawings appear on the draw buddy's immediately associated view only. The draw buddy provides access to a selection tool, an arrow tool, a formula tool, a text tool, and a box tool. Each draw tool is accessed by clicking on its button in the draw buddy window; its options and controls would then be presented in a separate floating window.

Draw tools provide elaborate support for augmenting graph views. Details are available in Appendix III.

6.6 One Point Buddy

The *One Point* buddy displays the coordinates of the point the cursor is currently over. It also provides a magnified view of the area around the point. The one point buddy is accessed by selecting *One Point* from the buddy mode pop-up menu at the top part of the floating window. Figure 6.11 shows the one point buddy:

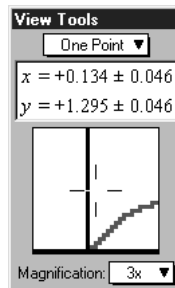
Figure 6.11: *The One Point buddy*

One point buddy controls apply to its immediately associated view only. The buddy elements are explained as follows:

Coordinates field The coordinates field displays the domain and range coordinates of the cursor point if the mouse cursor is within the graph view region. Coordinates values are given with error corrections.

Magnified view box The magnified view box displays a magnified view of the region around the cursor.

Magnification pop-up menu The *Magnification* pop-up menu is for changing the magnifying factor for the magnified view box. Supported magnification ranges from half-time($1/2x$) to five-times($5x$).

Tip: From within the one-point buddy, curve riding is possible by holding down the shift key while moving the mouse.

6.7 Two Point Buddy

The *Two Point* buddy displays the coordinates of two selected points A and B, and attributes of the line formed from joining A and B. The buddy is accessed by selecting *Two Point* from the buddy mode pop-up

menu at the top part of the floating window. The two points, A and B, can be relocated, one at a time, by clicking on them, then dragging them to new locations. Figure 6.12 shows the two point mode view buddy:

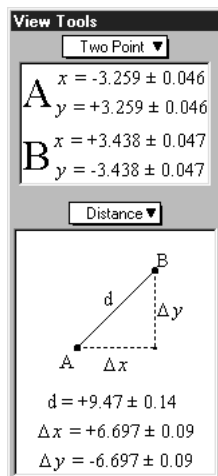

Figure 6.12: *The Two Point buddy*

Two point buddy controls apply to its immediately associated view only. Two point buddy elements are explained as follows:

Coordinates field The coordinates field displays the domain and range coordinates of A and B. Coordinates values are given with error corrections.

Attribute pop-up menu and attribute data field The attribute pop-up menu is for changing the data type displayed in the attribute data field. Attribute options are listed and described as follows:

- trig - cosine (Δx), and sine (Δy) of the line AB.
- slope - asymptote (h), and slope (m) of the line AB.
- distance - distance, Δx , and Δy between A and B.
- degrees - angle formed by the line AB and a horizontal line through A, in degrees.
- radians - angle formed by the line AB and a horizontal line through A, in radians.

All attribute data are given with error corrections.

Chapter 7

The Custom Ticks Window

The custom ticks window is for adding user specified ticks as interpretations aids to view windows. It can be brought up by selecting *New Custom Ticks* from the *Graph* menu. Figure 7.1 shows a blank custom ticks window:

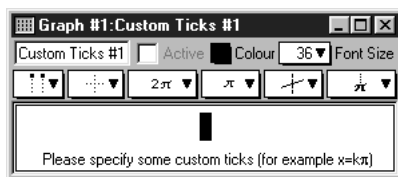

Figure 7.1: A blank custom ticks window

The custom ticks window consists of the following elements:

- a title bar,
- a parameter bar,
- a ticks control bar, and
- some tick specification fields.

Hint: The custom ticks window is very similar to the algebraic relation window. They have the following equivalent elements and properties:

- easy button support when editing constraint specifications,
- the title bar's elements and functions,
- the parameter bar's elements and functions,
- the constraint fields' elements and functions, and
- the optional keystroke field below the current constraint field.

This chapter still provides a complete explanation of these elements and properties so that the manual has a modular structure and can be used as a reference. The description for the equivalent elements and properties are mirrored in the Algebraic Relation Window chapter (page 3).

An easy button floating window is available for help in entering custom ticks specifications. Easy buttons are especially useful when entering symbols not readily available from standard keys on a keyboard, such as π , or any powers. For details, refer to the Easy Button Floating Window chapter (page 7).

The elements of the custom ticks window are explained as follows:

Title bar The title bar displays the graph title and the custom ticks title. The default title, “Custom Ticks #1”, can be changed using the parameter bar’s title edit box. Figure 7.2 shows the title bar:



Figure 7.2: *The title bar of the custom ticks window*

Parameter bar The parameter bar is for changing the title, showing and hiding the custom ticks, modifying the tick’s colour, and changing the font size used to display the tick’s specification. Figure 7.3 shows the parameter bar:



Figure 7.3: *The parameter bar of the custom ticks window*

The elements, from left to right on the custom ticks window parameter bar, are explained as follows:

Title edit box The title edit box is for changing the title of the current custom ticks specification. Title editing is useful in demonstrations and for print-outs. The default title, “Custom Ticks #1”, can be changed by clicking on the title edit box to access the edit mode. The new title will be reflected in all GrafEq menus, windows, and buttons that show the custom tick’s title.

Active checkbox The *Active* checkbox is for showing and hiding the custom ticks in all opened graph view windows. Clicking on the checkbox, or the checkbox name, toggles between the selected and unselected states. Deselecting the box hides the custom ticks from all graph views.

Hint: The *Active* checkbox is greyed out and unavailable if the custom ticks definition is not valid yet.

Colour pop-up menu The *Colour* pop-up menu is for changing the colour used for the custom ticks in graph views. This control is useful for optimizing the clarity of graph views. The colour can be changed by clicking on the *Colour* box to access the pop-up colour menu, then selecting the desired colour from it.

Font Size pop-up menu The *Font Size* pop-up menu is for changing the font size used to display the tick’s specification in the custom ticks window. The control is useful for presentations via an overhead liquid crystal display (LCD) or large screen television. The font size can be changed by clicking on the *Font Size* pop-up menu to bring up the menu of available font sizes, and then selecting the desired size from it. All constraints used for the tick specification will be displayed in the selected font size.

Hint: Some options in the custom ticks window’s parameter bar do not change behaviour or appearance within the custom ticks window itself:

- The *Active* checkbox affects the appearance (custom ticks display) in graph view windows.
- The *Colour* pop-up menu affects the appearance (custom ticks colour) in graph view windows.

Ticks control bar The ticks control bar is for changing the appearance of custom ticks in all view window(s) of the associated graph. The controls are for optimizing the readability of the custom ticks, and is useful in demonstrations and making print-outs. Figure 7.4 shows the ticks control bar.

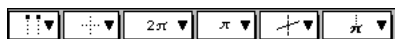

Figure 7.4: *The tick control bar of the custom ticks window*

The elements, from left to right on the custom ticks window tick control bar, are explained as follows:

Labels pop-up menu The labels pop-up menu is for changing which ends of the custom tick lines are labelled. This control does not affect polar views. Available options include:

- no labels,
- labels on the top (or left),
- labels on the bottom (or right),
- labels alternating between the top and the bottom (or left and right),
- labels alternating between the bottom and the top (or right and left), and
- labels on both the top and bottom (or left and right).

Figure 7.5 shows example views with various label options:

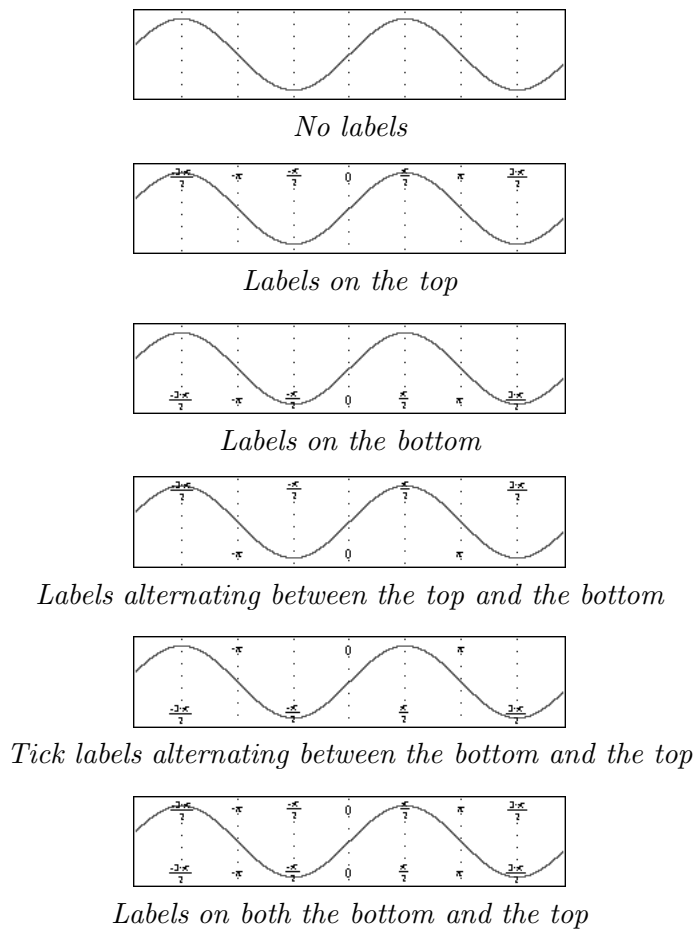

Figure 7.5: Example views with various label options

Line pop-up menu The line pop-up menu is for changing the style used to display the custom tick lines. This control affects both polar and cartesian views. Available options include:

- no lines,
- dotted lines,
- dashed lines, and
- solid lines.

Figure 7.6 shows views with various line options:

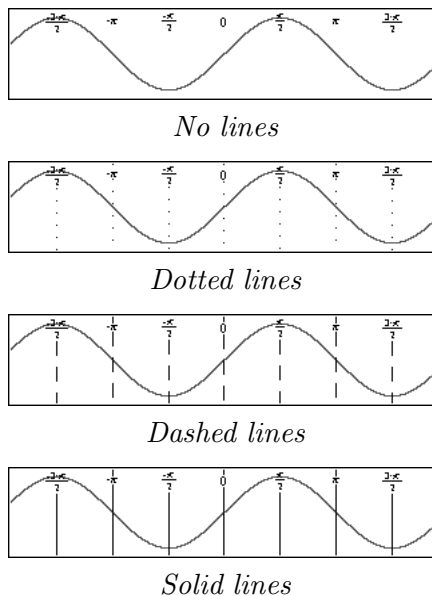

Figure 7.6: Views with various line options

Symbolic simplification pop-up menu The symbolic simplification pop-up menu is for changing how much simplification is to be applied to the custom tick labels. This control does not affect polar views. Available options include:

- none, for no simplification;
- bracketed, for simplified presentation of any parts within brackets; and
- complete, for a simplified presentation.

Figure 7.7 shows views with various symbolic simplification options:

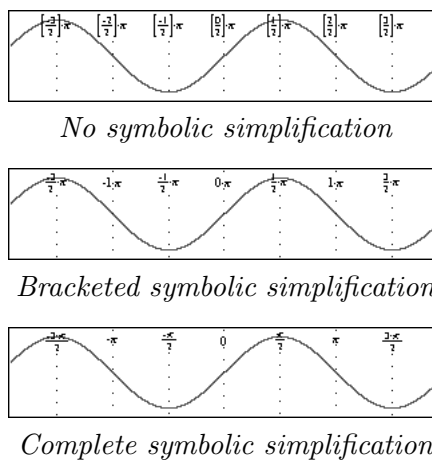

Figure 7.7: Views with various symbolic simplification options

Label font size pop-up menu The label font size pop-up menu is for changing the font size of the tick line labels. This control does not affect polar views. Eight sizes are available, ranging from very small fonts to very large fonts.

Outline pop-up menu The outline pop-up menu is for changing the thickness of any outlining around displayed custom tick lines and labels. Outlining is useful when parts of the custom ticks are obscured by graph regions. This control does not affect polar views. Available options include:

- no outline,
- minimal outline,
- moderate outline, and
- maximal outline.

Figure 7.8 shows views with various outline options:

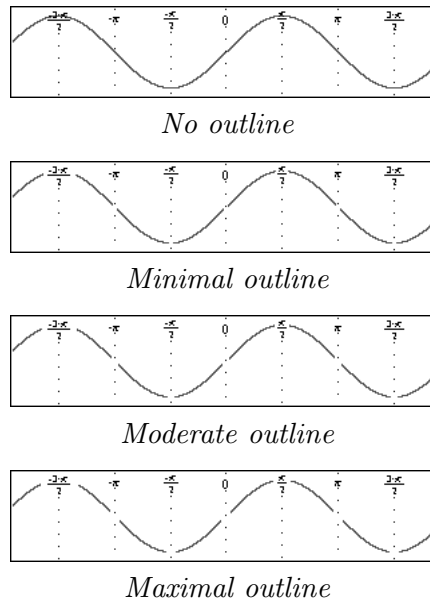

Figure 7.8: Views with various outline options

Display variable pop-up menu The display variable pop-up menu is for selecting whether or not the variable is displayed within tick labels. This control does not affect polar views. figure 7.9 shows views with, and without, the variable being displayed:

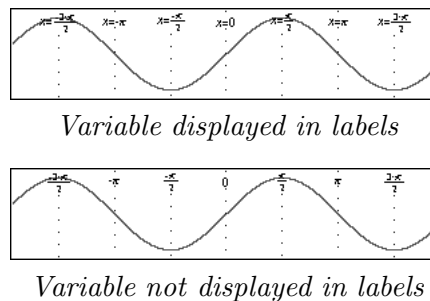

Figure 7.9: Views with, and without, the variable being displayed

Hint: All options in the custom ticks control bar only affect the appearance of custom ticks in graph view windows. They do not affect the behaviour or appearance within the custom ticks window itself.

Custom tick constraint fields Custom tick constraint fields are for specifying the custom ticks. They display the entered specification in standard mathematics notations. Prompts appear at the bottom of the field, while a constraint is being entered, to offer basic tips during the specification process. Figure 7.10 shows examples simple and complex custom tick specifications:

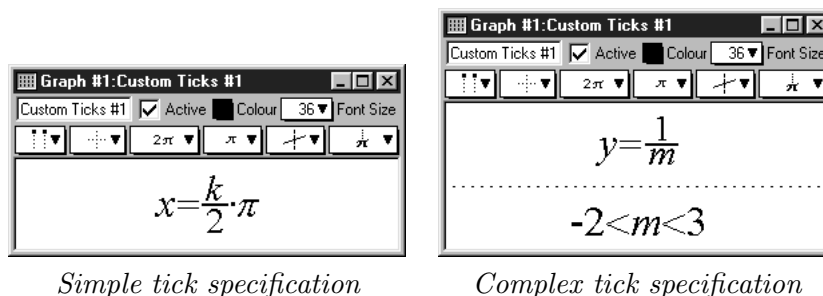

Figure 7.10: Custom ticks windows displaying simple and complex specifications

Custom ticks constraints should be specified in terms of the domain or range variable. The simple tick specification in figure 7.10 creates vertical ticks in multiples of $\pi/2$, which is especially useful for graphing trigonometric relations. Additional samples of useful tick specifications are provided at the end of this manual chapter.

While a constraint is being entered or changed,

- prompts appear at the bottom of the constraint field, and the easy button floating window is available to offer support for the specification process;
- a blinking cursor is present;
- the *Active* checkbox of the custom ticks window is unselected, and greyed out unless all constraints are valid;
- press the Tab key to move to the next constraint, or to create a new one if there is not a next constraint;
- press the Tab key while holding down the Shift key to move to the previous constraint, or to create a new one if there is not a previous constraint.

When functions are entered using multiple characters, the characters are unformatted, and presented in red, until GrafEq recognizes them as a function name: red signifies unrecognized entries. GrafEq can interpret “sin” as the sine function, instead of the product “ $s \times i \times n$ ”, only after an argument, such as x , is entered. A good example is the square root function, when entered as “sqrt”: GrafEq will replace the letters with a graphical radical symbol after an argument is started.

Hint: If the cursor is positioned away from the end of the constraint string during editing, all characters to the right side of the cursor become unformatted. With the default preference settings, unformatted characters are shown in solid red on colour displays, while they are outlined in black (not filled in) on black-and-white displays.

Tip: The “Symbol” and “Times” TrueType fonts must be installed in order to produce attractive screen output, unless the font settings have been changed in the preferences.

Tip: More information on the format and structure of constraints and the parser is available in the How GrafEq Works chapter (page 63).

Following are some additional hints and tips about custom ticks and the custom ticks window:

- Custom ticks are usually either domain or range interpretation aids: For cartesian views, they would be vertical or horizontal lines. For polar views, they would be radial lines emanating from the origin, or concentric circles about the origin. Custom ticks are usually specified in terms of the domain variable or the range variable. For both cartesian and polar views, custom ticks can be specified using r or θ .

- Each custom ticks window describes one set of custom ticks; the custom ticks can be defined using a single constraint, or by using multiple constraints. Additional constraint fields can be brought up by pressing the Tab key from within the custom ticks window.
- Each graph can have one or more sets of custom ticks. Each set is described in its own custom ticks window. Additional custom ticks windows can be opened by selecting *New Custom Ticks...* from the Graph menu.
- The keystrokes field is a strip beneath the current constraint field. It shows the keystrokes used to produce the formatted relation in the constraint field. Keystrokes information is especially useful when the intuitive mathematics symbols and notation have no obvious correspondence with the keys on a keyboard, such as π or any powers. Figure 7.11 shows a sample keystrokes field with its corresponding constraint field:

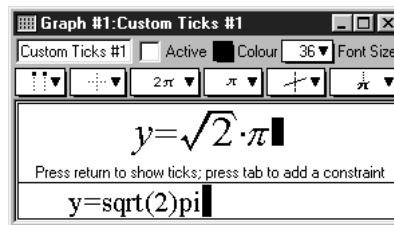

Figure 7.11: A custom ticks window with its keystroke field

Prior to version 2.04, GrafEq always provided this information via the keystroke field. But as of GrafEq 2.04, keystroke information can be revealed within the constraint fields by positioning the cursor to the left of the entries. The keystroke field is hidden using the default preferences, but remains useful for printing purposes. To display the keystroke field, change the default preference setting.

- A custom tick entry can be completed by selecting the *Active* checkbox of its custom ticks window or by pressing return. When custom tick entries are completed, the custom tick window will collapse to display just the title bar, parameter bar, ticks control bar, and constraint fields - prompts, the blinking cursor, the keystroke field, and the easy button floating window will disappear. The *Active* checkbox will be selected, but it can be freely deselected and selected without editing any constraints.
- Clicking within any constraint field of a completed custom ticks window will return you to the edit mode and remove the corresponding set of custom ticks from any opened graph views.

Conclusion

To conclude this chapter of the manual, following are some examples of useful tick specifications:

- For a single vertical tick line through $(\pi, 3)$, enter $x=\pi$.
- For horizontal tick lines through multiples of $1/2\pi$, enter $y=k(\pi/2)$.
- For “log-paper”, enter $x=10^k$.
- For “cross-hairs”, enter $x=\pi$ for tick #1, and $y=\log\pi$ for tick #2.
- For circular ticks, in polar as well as cartesian views, enter $r=k$.
- For radial ticks, in polar as well as cartesian views, enter $\theta=k(\pi/6)$.

Tip: Single tick lines or cross-hairs are desirable especially if memory is low or only specific regions are of interest. To the custom ticks $x=10^k$, adding a constraint such as $0 < k < 4$ allows GrafEq to concentrate on the region of interest.

Further, the relation specification itself might also be modified to stand out specific regions of interest, in which case GrafEq need not bother with any custom ticks at all and can concentrate on graphing the relation. Mastering relation specification would take time and practise, but it can be done, and it is fun!

Chapter 8

The Page Window

The page window is for preparing pages for printing. Pages can contain graphs, formulae, and text, augmented by arrows, and delineating rectangular boxes. The page window is brought up by selecting *New Page* from the *Graph* menu. Figure 8.1 shows a page window containing a graph view along and the relation for the graph, “ $y=\sin x$ ”:

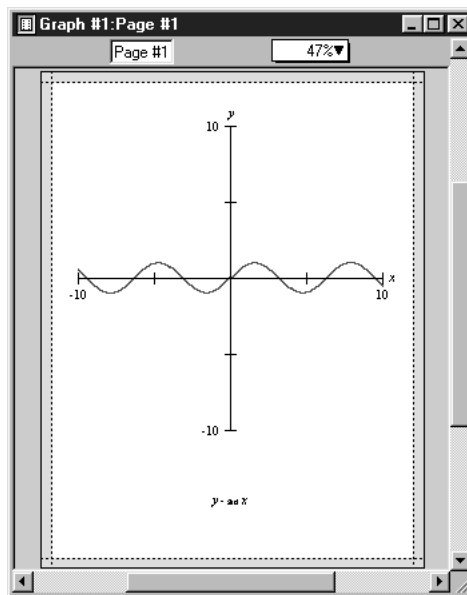

Figure 8.1: A typical page window

The page window consists of the following elements:

- a title bar,
- a parameter bar, and
- a page region.

The elements of the page window are explained as follows:

Title bar The title bar displays the graph title and the page title. The default page title can be changed using the parameter bar’s title edit box. Figure 8.2 shows the title bar:



Figure 8.2: *The title bar of a page window*

Parameter bar The parameter bar is for customizing the page title and changing the scaling factor used to display the page on the screen. Figure 8.3 shows the parameter bar:



Figure 8.3: *The parameter bar of a page window*

Following are the elements, from left to right, on the parameter bar:

Title edit box The title edit box is for changing the title of the current page. Title editing is useful during demonstrations and for print-outs. The default title, “Page #1”, can be changed by first clicking on the title edit box to enter the edit mode, and then changing the title name. The new title will be reflected in all menus, windows, and buttons that show the page title.

Page scale pop-up menu The page scale pop-up menu is for changing the scaling factor used to display the page on the screen. As a default, GrafEq uses the largest scaling factor that can display an entire page without scrolling. The scale can be changed by clicking on the page scale pop-up menu to bring up a list of available scale factors, and then selecting from the list. A small scaling factor can be used for display on a small monitor; A large scaling factor can be used to magnify the page content for close examination and precise editing. Scroll bars would be provided when the page content is larger than the page window.

Page region The page region displays the page being prepared for printing. The licensee name is always displayed on the top left corner of the page. The page can also include graphs, formulae, and text, augmented by pointer arrows, and delineating rectangular boxes. When a page window is foremost, a page buddy floating window appears to offer drawing tools for augmenting the page, and printing tools for printer control and printing.

Hint: The drawing tools of the page buddy are the same as those offered by the view buddy.

Conclusion

To conclude this chapter of the manual, following are some additional hints and tips about the page window:

- Each page window is associated with one graph, and can be used to display any number of the graph’s relations and views, as well as additional drawings, descriptions, and illustrations.
- A graph can have any number of pages. Additional page windows may be opened by selecting *New Page* from the *Graph* menu.

Chapter 9

The Page Buddy Floating Window

The page buddy window is for accessing drawing tools and printing controls for its associated page. It appears automatically when a page window is foremost. Figure 9.1 shows the page buddy floating window:

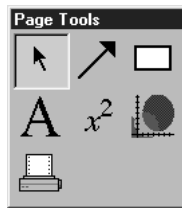

Figure 9.1: *The page buddy floating window*

The page buddy provides the following tools:

- 5 general drawing tools:
 - a selection tool, for selecting objects;
 - an arrow tool, for drawing arrows and lines;
 - a box tool, for drawing rectangular boxes;
 - a text tool, for adding text annotations; and
 - a formula tool, for adding formula annotations.
- a graph view tool, for adding graph views; and
- a printing tool, for selecting, configuring, and using a printer.

Before going into details about the different tools of the page buddy, following are some hints about the floating window, its appearance, and some general use instructions:

- The page buddy floating window appears only when a page window is foremost. It is otherwise hidden, but returns when a page window is activated.
- Each tool is accessed by clicking on a button in the page buddy floating window. Controls and options for the selected tool are presented in an associated, but separate, *Draw Tools* floating window.
- The selection tool on its own is not associated with any additional options, or *Draw Tools* floating window; however, when an object is selected, the *Draw Tools* floating window associated with the type of object currently selected will appear to allow editing of the object.

- Following are some general use instructions for options provided in *Draw Tools* floating windows:
 - Selecting an option’s checkbox activates the option; clicking on a checkbox or its name toggles between its selected and unselected states;
 - Clicking on a pop-up menu opens the pop-up menu, so the desired option can be selected from it.

9.1 General Draw Tools

General draw tools provide many elaborate tools for augmenting pages for printing. Details about each of them are explained in Appendix C, the Draw Tools appendix (page 87).

Hint: General draw tools in the page buddy is the same as those in the view buddy.

9.2 Graph Tools

Graph tools are for pasting selected graph views onto a page. Figure 9.2 shows the graph draw tool floating window:

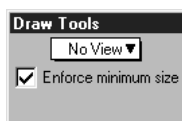

Figure 9.2: *The Graph Draw Tool Floating Window*

The elements, from top to bottom in the graph draw tool floating window, are explained as follows:

View pop-up menu The view pop-up menu is for selecting a view to the clipboard, for subsequent pasting to the page.

Enforce Minimum Size checkbox The *Enforce Minimum Size* option is for imposing a 25% limit for a pasted graph views’s minimum size. If the option is not selected, pasted views can be shrunk arbitrarily small.

9.3 Print Tools

Print tools are for Figure 9.3 shows the print draw tool floating window:

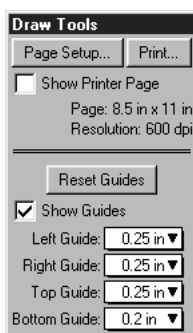

Figure 9.3: *Printer controls in a draw tool floating window*

The elements, from top left across to bottom right in the print draw tool floating window, are explained as follows:

Page Setup button The *Page Setup* button is for accessing the operating system's standard page setup window. Options may include paper size, paper source and orientation, graphic resolution, number of copies to be printed, and which printer to print to.

Print button The *Print* button is for accessing the operating system standard print window. The print window is for sending the current print page to a printer; it may also include some options that influence the printing process.

Show Printer Page checkbox The *Show Printer Page* option is for displaying of the limits that the print head can reach on the physical paper.

Page size and printer Resolution *Page* displays the print page dimensions in inches; *Resolution* displays the resolution in dots-per-inch, "dpi".

Reset Guides button The *Reset Guides* button is for changing all margins back to the default setting. Default margins are set to a minimum, and the guides would overlap with the printer page.

Show Guides checkbox The *Show Guides* option is for outlining, with dotted line, the page area on which page contents are to be printed.

Pop-up menus for Left, Right, Top and Bottom Guides The guide pop-up menus are for changing the respective print margins.

Hint: Margins can also be set by clicking at the respective guide box on the page, then dragging it to the desired position.

Chapter 10

The Menu Bar

The menu bar is for accessing functionalities provided in the pull-down menus. It is located just below the GrafEq window title bar, and is always present. The menu bar can contain the following elements:

- *File* menu,
- *Edit* menu,
- *Graph* menu,
- *Relation* menu, and
- *Custom Ticks* menu.

Hint: *File* and *Edit* menus are always present; but

- *Graph* menu is present only when there is one or more active graphs;
- *Relation* menu is present only when an algebraic window or structural window is foremost; and
- *Custom Ticks* menu is present only when a custom ticks window is foremost.

10.1 File Menu

The *File* menu is divided into six groups: “opening and creating”, “configuring”, “closing and saving”, “printing”, “selecting”, and “terminating”. Figure 10.1 following is the file menu:



Figure 10.1: *The File menu*

- Opening and creating
 - **New Graph** creates a new graph, and brings up a new algebraic window for the new graph's first relation. The new graph will be assigned a new title, using a new sequence number.
 - **Open...** lets you open a saved graph from disk. Preference files may also be opened, although a few preferences (such as interface language) only apply at startup.
- Closing and saving
 - **Close Graph** closes all windows associated with the foremost graph.
 - **Close Window** closes the foremost window.
 - **Save Graph** saves the current graph to disk. GrafEq supports two file formats:
 - * Full Graph - all information, of the current graph, including relations, views, pages, ticks, and the current plotting state is saved. A full graph can later be opened in the exact same state as when it was saved. Partially plotted graphs can be refined from where it was left off. Full graphs can use a significant amount of disk space.
 - * Skeleton Graph - all information, of the current graph, excluding the current plotting state, but including relations, views, pages, and ticks, is saved. When a skeleton graph is re-opened, graph plotting will start over, because the skeleton file format does not save the plotting state. Skeleton graphs use very little disk space.
 - Hint:** When GrafEq's preferences window is foremost, a **Save Preferences** item replaces the **Save Graph** item, and it lets you save the current preferences.
 - **Save Graph As...** lets you save a graph to a new file. Other than letting you choose a new name and location for the file, **Save As...** is identical to **Save**.
 - Hint:** When GrafEq's preferences window is foremost, a **Save Preferences As...** item replaces the **Save Graph As...** item, and it lets you save the current preferences to a new file. GrafEq looks for a preference file named "GrafEq Preferences" at startup, which is the default name used for saved preferences.
 - **Export...** lets you save a view to a new file; when a view window is foremost this item is replaced with an **Export View...** item. With Windows, it is saved using the WMF format. With a Macintosh, it is saved using the PICT format. Exported views can be re-opened in GrafEq as a picture only; the defining relations will not be available. However, exported views may also be opened, and modified, in painting and drawing programs.
- Printing
 - **Page Setup...** opens the operating system's standard page setup window. Options may include the paper size, paper source and orientation, printing resolution, and the number of copies to be printed.
 - **Print...** opens the operating system's standard print window. The print window is used for sending a page to a printer; it may also include some options that influence the printing process.

Hint: GrafEq supports printing via the creation of pages which can be invoked by selecting New Page from the Graph menu. For details, refer to the Page Window chapter (page 39).
- Selecting

Selection controls provide access to all open graphs. Each is listed using its current title. Selecting a graph causes it to become the current graph, and its first algebraic relation window to become the foremost window.

- Configuring
 - **Preferences...** brings up the preferences window, which is for setting up the GrafEq environment for current and/or future sessions. Many elaborate controls are accessible from the *File Preferences* menu; for details, refer to the Preferences chapter (page 51).
 - **Register...** lets you register your copy of GrafEq. This menu option is not present in physically licensed copies of GrafEq.
- Terminating
 - **Halt Graphing** stops graph plotting in all open views.
 - **Quit** closes the current GrafEq session.

10.2 Edit Menu

The *Edit* menu is for accessing *Cut*, *Copy* and *Paste* operators, as explained following:

- **Undo** is not yet functional. the menu item positioning
- **Cut** removes the selected content from its current location, and keeps a copy on the clipboard.
- **Copy** copies of the selected content to the clipboard.
- **Paste** inserts the clipboard's contents into the current position. If some content is selected (and there is no current position), the selection is replaced with the clipboard's contents.
- **Clear** deletes the selected content.
- **Select All** selects all of the content in the current window.
- **Cut and Copy as Text**; when selected, relations copied from the algebraic window will be copied to the clipboard as plain text.
- **Cut and Copy as a Drawing**; when selected, relations copied from the algebraic window will be copied to the clipboard as a (vector) drawing. Drawings are usually preferable to Images as they require less memory for high resolution output.
- **Cut and Copy as an Image**; when selected, relations copied from the algebraic window will be copied to the clipboard as a (bitmap) image.

- Tip:**
- Editing is useful when working on algebraic relations and general text within GrafEq.
 - By copying and pasting to word processing, drawing, and other programs GrafEq's formatted relations and plotted graph views can be used included in mathematical reports, hand-outs, books, etc.
 - To fine-tune alignment when pasting to a word processor, try the word processor's superscript of subscript effects.
 - To achieve best results when printing a document containing a GrafEq graph, try changing options within the *Page Setup* or *Print* of the program used.

- GrafEq provides some basic drawing tools; for elaborate drawing effects, it is also possible to first paste a GrafEq entity into a drawing program, to fine tune the picture, and then copy it from the drawing program to the destination application.

Hint: However, editing options are not available in the following situations:

- When the view window is foremost,
 - while *Copy* is allowed, because the contents of the view region can be copied, and then pasted to other applications,
 - the *Cut* and *Paste* operators are greyed out (unavailable), because the view window is for displaying graph views and the plotting process, and does not allow changes to it.
- When the page window is foremost, the entire Edit menu is greyed out (unavailable), because editing in the page window is provided via the page buddy floating window.
- When the structural relation window is foremost, the entire Edit menu is greyed out (unavailable), because the structural window is for displaying the tree structure of its associated relations, and does not allow any editing.

10.3 Graph Menu

The *Graph* menu is for creating and displaying graph elements.

- Creating
 - **New Relation** creates an algebraic relation window for entering a new relation.
 - **New View...** opens the create view window, from which a graph view can be created.
 - **New Custom Ticks** creates a custom ticks window for specifying a new set of custom ticks.
 - **New Page** creates a page window for preparing a page for printing.
- Displaying elements

Display controls provide access to all open relations, views, custom ticks, and pages of the current graph; each listed with its respective title. The window for the selected item becomes the foremost window.

10.4 Relation Menu

The *Relation* menu is for controlling the display of relation elements and the easy button floating window.

- **Algebraic Window** toggles the display and hiding of the algebraic window of the current relation. If displayed, the window will also become the foremost window.
- **Easy Buttons** toggles between the hiding of the easy button floating window, and its display when any constraints or expressions are being edited. The option for the easy button floating window is global and applies to the current GrafEq session.
- **Structural Window** toggles the display and hiding of the structural window of the current relation. If displayed, it window will also become the foremost window.

10.5 Custom Ticks Menu

The *Custom Ticks* menu offers an **Easy Buttons** control, which is the same as, and synchronized with the easy button control from the **Relation** menu, and is for toggling between the hiding of the easy button floating window, and its display when any constraints or expressions are being edited. As mentioned under the **Relation** menu section, the option for the easy button floating window is global and applies to the current GrafEq session.

Chapter 11

Preferences

Preferences are for setting defaults for some GrafEq features, behaviour and appearances. Some advanced features are also only accessible or controllable from within the preferences window. The preferences window can be opened by selecting *Preferences* from the *File* menu.

Figure 11.1 shows the preferences window as it appears by factory default; preferences are organized mainly by windows, while a few general preferences for file access control and interface languages are also provided.

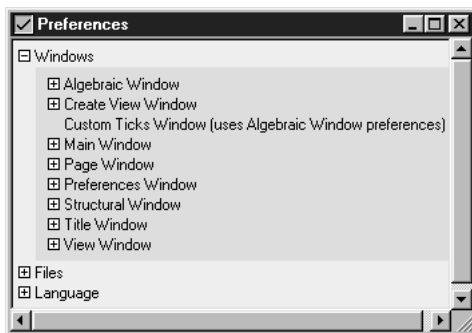

Figure 11.1: *The GrafEq preferences window*

Before going into details about preferences, following are some general hints about the effects of preference settings and some general use instructions:

- Most preference settings take effect immediately, but some take full effect only in subsequent sessions; nevertheless, full preference changes can always be activated immediately by quitting and restarting GrafEq.
- Default means that the settings apply to all appropriate cases, across sessions, and every time GrafEq is started. Default settings can be changed ‘on the fly’, while GrafEq is running, but the changes will apply only to individual graphs or windows, and will not affect the defaults; the next time GrafEq is started, default settings would be back in effect.
- Checking an option’s checkbox activates the option; clicking on a checkbox or the checkbox’s name toggles between its checked and unchecked states.
- Clicking on a pop-up menu brings up a pop-up list or table, so the desired option can be selected from it.

- Some preference controls are offered in lists, as in the *Ticks Defaults* preferences. Lists have the following general properties:
 - Lists can be toggled between an expanded and a collapsed state, by clicking on the name of the list, or on the box adjacent to it.
 - Expanded lists reveal the respective list elements and/or sub-lists. List elements revealed can then be customized individually; and sub-lists can then be further expanded, or collapsed. The same rules that apply to lists also apply to sub-lists.
 - Some lists also come with checkboxes adjacent to their respective boxes. (Most lists in the *Ticks Defaults* preferences have them.) The list box can be checked or unchecked to conveniently, and collectively, select or deselect *all* element options covered by the list. A list which has selected as well as unselected elements displays a horizontal bar in its checkbox.

11.1 Windows Preferences

Windows are listed in alphabetical order of window names, as seen in figure 11.1 earlier.

11.1.1 Algebraic Window Preferences

Hint: Algebraic window preferences also control the custom ticks window settings.

Controls cover the clipboard, easy buttons, display fields, and the teleprompter. Figure 11.2 shows algebraic window preferences:

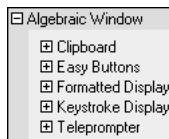

Figure 11.2: *Algebraic window preferences*

- *Algebraic Window - Clipboard*
Clipboard Preferences are for setting appearances and formats to be used when exporting from GrafEq's algebraic windows to the clipboard. Figure 11.3 shows clipboard preferences:

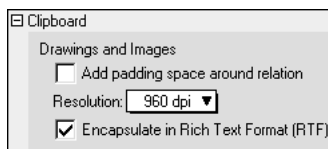

Figure 11.3: *Algebraic window clipboard preferences*

- *Add padding space around equation* checkbox
Select this option to place a small amount of white space around relations copied to the clipboard. Has no effect when copying relations as text.
- *Resolution:* pop-up menu
Select the resolution to use for relations copied as drawings and images. With images, higher resolutions will create clearer output but will also use more memory. With drawings, higher resolutions will allow for more precise placement of the elements making up the relation.

- *Encapsulate in Rich Text Format (RTF)* checkbox
Select this option to format relations with RTF. RTF formatting can help word processors position relations vertically. Has no effect when copying relations as text.
- *Algebraic Window - Easy Buttons*
Easy buttons preferences are for setting defaults to show, or not show, the easy button floating window; and setting access to each easy button group. Figure 11.4 shows easy buttons preferences:

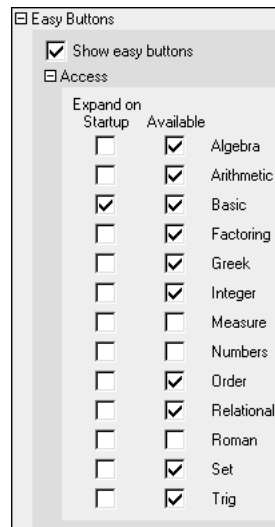

Figure 11.4: *Algebraic window easy buttons preferences*

- *Show easy buttons* checkbox
Select the option to show the easy button floating window every time GrafEq starts up. After startup, display of the easy button floating window is controlled by accessing GrafEq's *Relation* menu or *Custom Ticks* menu, from which *Easy Buttons* can be toggled between the selected state (to show the window), and the de-selected state (to hide the window).
- *Access list*
 - * *Expand on Startup* checkbox and *Available* checkbox for each easy button group
Select the respective *Available* checkboxes to display the headings of desired easy button groups; to expand any selected groups (display the individual easy buttons under the headings), select also the respective *Expand on Startup* checkboxes.
Tip: While *Available* options are only accessible from the preferences window, expand, or collapse, under each group heading can also be conveniently toggled from within the easy button floating window.
- *Algebraic Window - Formatted Display*
Formatted display preferences are for setting font type, default font size, and appearances of entries in the algebraic window's constraint field(s). Figure 11.5 shows formatted display preferences:

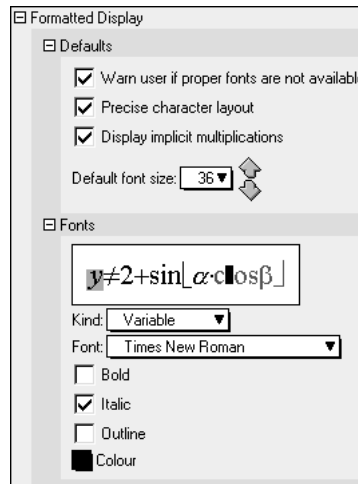

Figure 11.5: Algebraic window formatted display preferences

– Defaults list

- * *On startup, warn user if proper fonts are not available* checkbox
Select this option to warn user every time GrafEq starts up if proper fonts are not available.
- * *Precise character layout* checkbox
- * *Display implicit multiplications* checkbox
- * *Default font size...* pop-up menu, with up and down arrow buttons
The up arrow button is for stepwise size increment; the down arrow button, stepwise size decrement.

– Fonts option list

- * *Effects sample box*
The effects of the current font options set under this manual section is displayed here for convenient examination.
The highlighted character(s) represents the currently selected character kind; its selection, font type, and appearance each corresponds to the respective option settings listed below the effects sample box.
- * *Character Kind* pop-up menu
This *Kind* pop-up menu lists: formatted character kinds (entries to the left side of the mouse cursor), then a separator line, and finally unformatted character kinds (entries to the left side of the mouse cursor).
The character kind selected will be highlighted in the effects sample box. Selection can be changed by either clicking any characters of the desired kind within the effects sample box, or from the *Kind* pop-up menu.
Hint: The current option in the *Kind* pop-up menu and the kind of characters highlighted in the sample box are synchronized.
- * Font setting controls include:
 - a *Font* type pop-up menu,
 - a *Bold* checkbox,
 - a *Italic* checkbox,
 - a *Outline* checkbox, and
 - a *Colour* pop-up menu.

Any changes in the font settings will apply only to the currently selected / highlighted character kind, and will take effect immediately in both the sample box, and the algebraic window.

Hint: The font settings shown and the appearances of the highlighted characters in the sample box are synchronized.

- Tip:**
- * Symbol character kinds, for both formatted and unformatted sections, should use symbol font only.
 - * Experiment with the various options and see the effects.

- *Algebraic Window - Keystroke Display*

Hint: As of GrafEq version 2.04, keystroke information is available directly from the constraint field, by positioning the cursor to the left of the entries. The keystroke field remains useful for printing purposes, but has been set to be hidden by default preference settings.

Keystroke display preferences is for setting to show, or not show the keystroke field (which would be a strip field beneath the current constraint field), and setting font type, and appearances of entries in the keystroke field. Figure 11.6 shows keystroke display preferences:

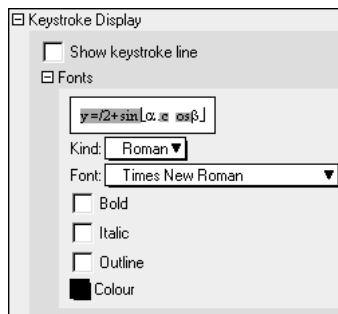

Figure 11.6: *Algebraic window keystroke display preferences*

- *Show keystroke line* checkbox
Select this option to show the keystroke line when a constraint is being entered or edited.
- *Fonts* option list
Fonts options are essentially identical to those for the formatted display, except that these options apply to entries to the keystroke display field.

- *Algebraic Window - Teleprompter*

The teleprompter preference is for toggling to show, or not show the teleprompter (which would be the user hint shown at the bottom of an active constraint field). There is just one preference option, provided by the *Show teleprompter* checkbox. Figure 11.7 shows the teleprompter preference:

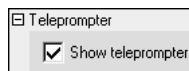

Figure 11.7: *Algebraic window teleprompter preferences*

11.1.2 Create View Window Preferences

Create view window preferences are for setting default options covering automatic graphing, colour view and view size, and interface options covering user access to these create view settings and controls. Figure 11.8 shows create view window preferences:

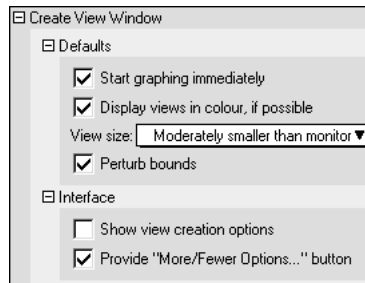

Figure 11.8: *Create View Window preferences*

- *Defaults* list:

- *Start graphing immediately* checkbox
Select this option for automatic graphing when a new view is opened. De-select this option and graphing in a view window has to be activated by selecting the *Graph* checkbox in the view window's parameter bar.
- *Display views in colour, if possible* checkbox
De-select this option to display graph views in black and white, which might be desired such as in printing.
- *View size:...* pop-up menu
Selectable view sizes are relative to the monitor size.
- *Perturb bounds* checkbox
Select this option to enlarge bounds by about 0.01. Graphed lines will always have uniform thickness (because lines like $x=0$ will fall upon a column or row of pixels rather than in between two columns or rows).

Hint: Defaults apply to all create view windows. Settings for individual create view windows can be changed from within that create view window if either of the interface options, described in the following section, are selected.

- *Interface* options list:

- *Provide "More/Fewer Options..." button* checkbox
Select this option to provide a "More/Fewer Options..." button at the bottom center of each create view window. The button allows view creation options to be displayed or hidden anytime from within the create view window. Displayed options can then be customized for the current view creation.

Hint: When create view options are hidden, the button would be labelled *More Options* and is for revealing the options; When create view options are shown, the button would be labelled *Fewer Options* and is for simplifying or minimizing the create view window.

- *Show view creation options* checkbox
Select this option to show the individual create view options.

Hint: The setting of this option solely determines the accessibility of view creation options if the "More/Fewer Options..." button is not provided within the create view window.

11.1.3 Custom Ticks Window Preferences

Custom Ticks Window uses the same preference settings as the algebraic window.

11.1.4 Page Window Preferences

Page window preferences are for setting the frequency at which page window contents are to be updated from any graph views, and setting font size for the page window to suit printing needs. Figure 11.9 shows page window preferences:

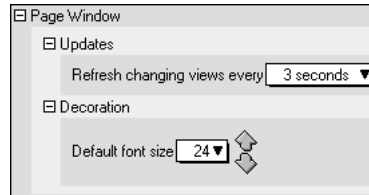

Figure 11.9: *Page window preferences*

- *Updates* preference is provided by the *Update from view window every...* time interval pop-up menu.
- *Decoration* preference is provided by the *default font size* pop-up menu.

Tip: The page window might flash when it is updated; the advantage of showing current contents should be weighted against possible flashing of the display.

11.1.5 Preferences Window Preferences

Preferences window preferences are for controlling access to preferences settings, and saving of preference changes. Figure 11.10 shows preferences window preferences:

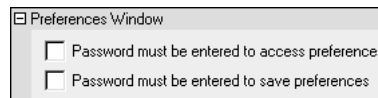

Figure 11.10: *Preferences window preferences*

- *Password must be entered to access preferences* checkbox
Select this option to restrict any access to the preferences window and settings.
- *Password must be entered to save preferences* checkbox
Select this option to restrict changes to the preferences file; if the preferences window is accessible, preferences can be changed for the current GrafEq session, but saving of the changes is restricted by password.

Hint: The same password will be used for restricting access to preference settings and saving, as well as access to file loading and saving. A user specific password is supplied with registration.

11.1.6 Structural Window Preference

The structural window preference is for setting defaults to present commutative relations either as processed flat tree structures, or as original/unprocessed full-blown trees. The control is provided by the *Combine commutative* checkbox. Figure 11.11 shows structural window preference:

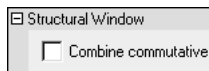

Figure 11.11: *Structural window preference*

11.1.7 Title Window Preference

Title window displays the GrafEq version logo in an attractive splash screen. One prefer control is offered for the title window, by the *Minimum number of available colours to justify using colour...* number pop-up menu. Figure 11.12 shows title window preference:

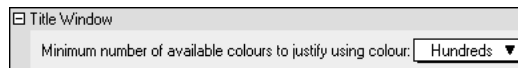

Figure 11.12: *Title window preferences*

11.1.8 View Window Preferences

Controls cover the clipboard, view colours, information, ticks, view and zoom. Figure 11.13 shows view window preferences:

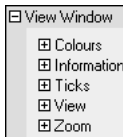

Figure 11.13: *View window preferences*

- *View Window - Colours*

Colours preferences are for setting default appearances, and colours and patterns for graph views. Figure 11.14 shows colour preferences:

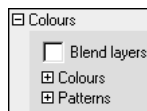

Figure 11.14: *View window colours preferences*

- *Blend layers* checkbox

Select this option to blend relation colours in any intersecting regions when a graph displays multiple relations. De-select this option to have the colours or patterns of the relations pile up in opaque layers.

- *Colours* list:

- * *Background colour* pop-up menu

- * *Layer colours* pop-up menus The default colours of the first 15 relations can be specified in these 15 *Layer colours* pop-up menus. A combination of light coloured background and dark coloured relations, or vice versa, generally enhances readability.
- *Patterns* list:
 - * *Background colour* pop-up menu The default background colour can be either white or black. White background generally enhances readability.
 - * *Layer patterns* pop-up menus The default patterns of the first 15 relations can be specified in these 15 *Layer patterns* pop-up menus.
- *View Window - Information*

Information preferences are for setting updating frequency, and optional displayed data items for the view window's information view buddy. Figure 11.15 shows information preferences:

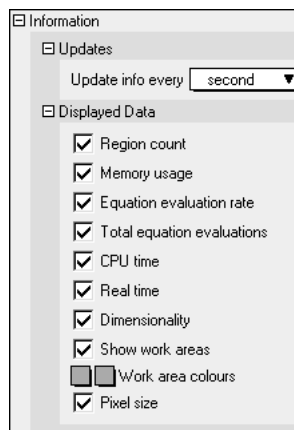

Figure 11.15: *View window information preferences*

- *Updates - Update info every...* time interval pop-up menu
Select a rate just frequent enough to display reasonably timely information, because fast changing data can be hard to read. GrafEq constantly monitors memory conditions anyway.
- *Displayed Data* list:
 - * *Region count* checkbox
 - * *Memory usage* checkbox
 - * *Equation Evaluation Rate* checkbox
 - * *Total Equation Evaluations* checkbox
 - * *CPU time* checkbox
 - * *Real time* checkbox
 - * *Dimensionality* checkbox
 - * *Show work areas* checkbox
 - * *Work area colours* colour pop-up menus
 - * *Pixel size* checkbox

All the data options are selected by default preferences. Refer to the View Buddy Floating Window chapter (page 21) for detailed meaning and useful application of information buddy's displayed data.

- *View Window - Ticks*

Ticks preferences are for setting when to show created ticks, and setting optional default components and default appearances of ticks in graph views. Figure 11.16 shows information preferences:

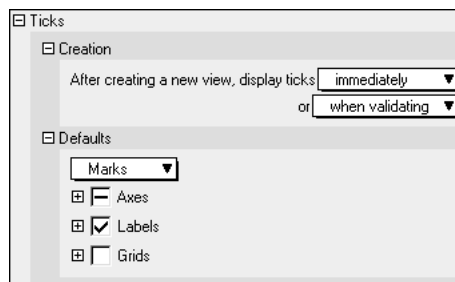

Figure 11.16: *View window ticks preferences*

- *Creation* preference is for setting when to show newly created ticks in graph views. Displaying immediately might be convenient; displaying later might speed up graphing. The preference is provided by:
 - * *After creating a new view, display ticks...* time pop-up menu, and
 - * *or...* state pop-up menu.
- *Defaults* preferences are for setting default components and appearances of ticks in graph views. The option interfaces are essentially identical to those in the Ticks view buddy, except that preferences are for setting defaults while view buddy controls affects the current GrafEq session only. Refer to the View Buddy Floating Window chapter (page 21) for details of the controls.

- *View Window - Calculations*

View preference is for setting arithmetic rounding rules. One preference options is offered, by the *Calculations - Perform arithmetic with outward rounding* checkbox. Figure 11.17 shows the view calculation preference:

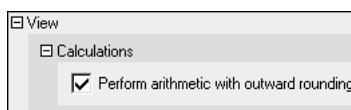

Figure 11.17: *View arithmetic preferences*

- *View Window - Zoom*

The *Zoom* preference is for setting defaults to keep or replace the original view on zooming. One preference option is offered, by the *Keep the old view after zooming* checkbox. Figure 11.18 shows the zoom preference:

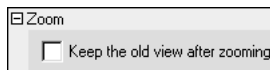

Figure 11.18: *Zoom preferences*

11.2 Files Preferences

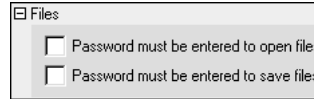

Figure 11.19: *Files preferences*

Files preferences are for controlling access to file loading and saving/changing, by the *Password required for opening files* checkbox and *Password required for saving files* checkbox.

Hint: The same password will be used for controlling access to preference settings and saving, as well as access to file loading and saving. A user specific password is supplied with registration.

11.3 Language Preference

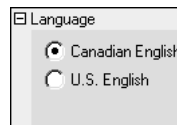

Figure 11.20: *Language preferences*

The language preferences allow you to select which language is used for GrafEq's interface.

Conclusion

The preferences window is for changing settings that apply every time GrafEq is started. Many of these settings can be changed when GrafEq is running, but the changes will apply only to individual graphs or windows and will not affect the defaults.

Chapter 12

How GrafEq Works

The general GrafEq environment is that relations are entered in algebraic windows, and plotted in view windows. Then relations and views can be prepared for printing in page windows.

GrafEq also has many features of interest to the sophisticated user, including its relation parser, plotting technique, and memory management.

Hint: Useful and interesting hints and tips relevant to the immediate topic are offered throughout this GrafEq manual. Most chapters are also concluded with general hints and tips for the chapter topic. *Hints* are observations that often helps understanding; *Tips* are possible actions that often helps efficiency or effectiveness. They might simply be interesting side notes too.

12.1 The Algebraic Relation Parser

GrafEq's algebraic relation parser understands conventional mathematics notation, which helps make the program intuitive to those familiar with such notation, and encourages students to learn the standard notation. Some characteristics are explained as follows:

- A relation can contain one or more constraints. Each constraint must be a valid relation. The graph of a relation given by multiple constraints is the intersection of the graphs given by the constraints taken individually. This interpretation can be further understood by opening a structural relation window.
- A relation can be an equation, an inequality, a set description, or a conditional or piecewise definition.
- A relation can be explicit or implicit: explicit if one of its variables is isolated on one side of the relation definition, implicit if neither of its variables is isolated.
- Conditional or piecewise descriptions are entered as follows: $y < \{x \text{ if } x^2 + y^2 \geq 5, \sin x \text{ if } (-1 < x < 2\pi), -5 \text{ if } x \in \{8, 18, 28, 38\}\}$
- Relations may be given using set notation, as follows: $a < \{b, c\}$, which is interpreted as the union of $a < b$ and $a < c$. GrafEq does not use a type-system, so that $x = \{1, 2\}$ is the same as $x \in \{1, 2\}$.
- Relation definitions must be in a valid form: for example; braces, brackets, and parentheses must be properly closed.

Tip: Older versions of GrafEq perform little symbolic manipulation, and plotting is primarily numeric. Natural pre-processing of expressions such as replacing “ $x^3 - x^3$ ” with a simple “0” might enhance efficiency significantly. Starting with version 2.04, GrafEq does simple pre-processing, so that it will recognize (and perform) simple replacements that improve graphing speed without changing the graph of the relation.

Rewriting and simplifying relations must be done very carefully! For example, “ \nless ” should not be re-written as “ $<$ ” because they are not equivalent in all cases. Figure 12.1 shows the graphs of “ $y \nless \text{Arccos}x$ ” and “ $y < \text{Arccos}x$ ” as plotted by GrafEq; they are not equal because $\text{Arccos}x$ is undefined for $x > 1$ and $x < -1$:

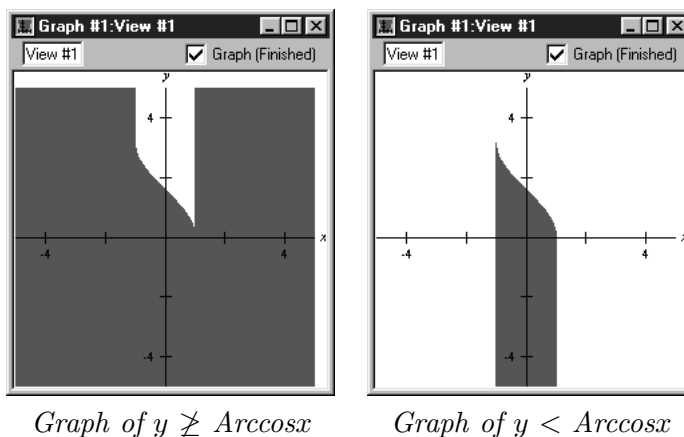

Figure 12.1: *Graphs plotted by GrafEq shows that “ \nless ” and “ $<$ ” are not the same*

12.2 The Plotting Technique - Successive Refinement

GrafEq’s graphing engine uses a unique plotting technique called successive refinement, which ensures that irregular graphs are plotted correctly. Details are explained as follows:

1. A view region is divided into rectangular sub-regions.
2. Each sub-region is examined:
 - if GrafEq can prove that the sub-region *does not* contain any solutions that satisfy any of the active relations, the sub-region does not form part of the final graph, and is never looked at again;
 - if GrafEq can prove that all points within the entire sub-region *does* satisfy an active relation, the entire sub-region forms part of the final graph, and is never looked at again;
 - if the sub-region lies within a single pixel and GrafEq can prove that a point within the sub-region *does* satisfy an active relation, the sub-region forms part of the final graph, and is never looked at again;
 - if GrafEq cannot prove one of the above three propositions, the sub-region is further examined:
 - if the sub-region cannot be further subdivided
 - * because it has become so small that the current number system cannot represent the required numbers, then GrafEq will state that “precision is exhausted”,
 - * because it has become too small relative to the size of a pixel, then GrafEq will state that “subdivisions are exhausted”;

- otherwise, the sub-region will be further subdivided, and each smaller sub-region will be examined just like its predecessor, as explained above.

Hint: A graph is drawn using the following rules:

- pixels that form part of the final graph have the (possibly blended) colours of the relevant relations;
- pixels that do not form part of the final graph have the colour of the view region’s background;
- and
- pixels that are not yet determined
 - have the (possibly blended) colours of the relevant relations, or
 - if the *Show Work* option, in the information view buddy, is selected, the colour of the work area.

Hint: GrafEq can correctly plot irregular graphs such as singularities and narrowly spiked curves. Figure 12.2 shows three stages in the plotting of “ $x(x+1)^2+y(y+1)^2=0$ ”:

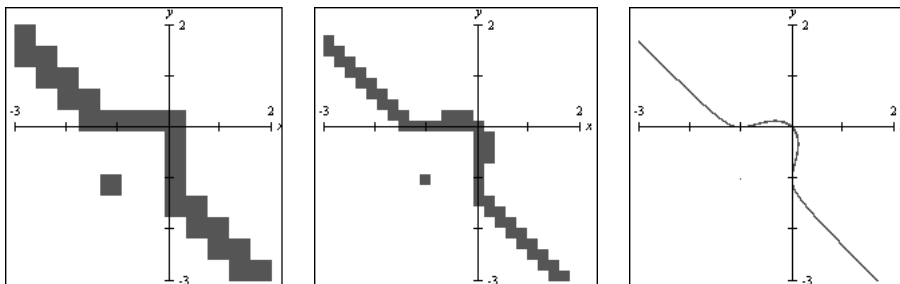

Figure 12.2: GrafEq plotting a relation with a singularity, in successive refinement

Tip: Graphing can be sped up if relations can be described as inequalities naturally. Inequalities are typically done more efficiently than equations.

Hint: GrafEq displays a “signature” at point-discontinuities.

Consider the relation $y=(x-1)(x+1)/(x-1)$. Its graph can be anticipated to be the line $y=x+1$ less the point $(1,2)$. However, when the relation is fed to a computer, while graphers using common sampling plotting techniques would likely miss the issue of the point discontinuity altogether, even GrafEq with its robust graphing engine cannot omit any pixels for the point $(1,2)$, because the pixel containing $(1,2)$ also contain many solutions in the real number continuum that satisfy the relation. In such cases, rather than just graphing the solid line $y=x+1$, GrafEq will often make the anomaly apparent, by displaying a signature at the point-discontinuity, as shown in figure 12.3:

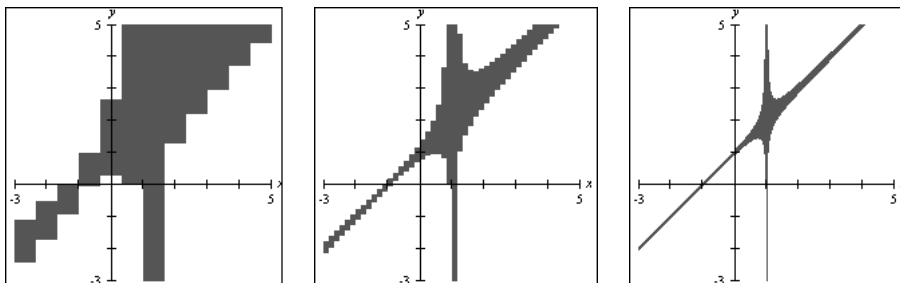

Figure 12.3: Graph with point discontinuity signature at $x=1$

Starting with version 2.04, GrafEq has an improved graphing engine which may not display discontinuity signatures (older versions may not either; the signature is a side-effect of the graphing process). Future versions will have added features, which will allow users to see undefined portions of a graph.

Tip: To achieve high precision, the view scope can be enlarged by setting large bounds from the create view dialog box. High precision is useful for printing very thin accurate curves via a high resolution printer. In general, a 600 to 2,450 dpi printer will generate good results with uniform ticks.

12.3 Memory and Speed

GrafEq provides a memory monitor to display information on memory usage. When the memory monitor shows that memory resources are becoming inadequate, the following actions might help:

- Quit any screen savers and applications that are opened but currently non-essential.
- Close any windows that are currently non-essential.
- Turn off the “Keep this view after zooming” option in the Zoom View Buddy.
- Turn off graph ticks wherever possible and appropriate.
- Set view windows and view scopes as small as possible.
- Keep the number of active plotting views to a minimum, just one if possible.
- If plotting additional relations in a view window, set other relations to inactive.
- Set all colours or patterns to solid black wherever appropriate.

More memory usage information is also provided in the Information View Buddy, including:

- the memory being used by each view and each relation;
- the time spent exclusively for graphing versus the total time elapsed, because the computer also spends time in re-drawing windows, and monitoring external events such as mouse clicks, key presses.

Actions that relieve memory inadequacy generally help graph plotting speed too, while the following steps mainly enhances the latter.

- preprocess the relation, such as replacing “ x^2-x*x ” with “0”;
- use same colour output instead of black and white patterns;
- use solid black instead of patterns or colours during plotting - patterns and colours can be reset after plotting is completed.

Tip: Any computationally intensive program will run more efficiently on a fast machine with generous memory resources. For specific information on how a computer system manages memory, refer to documentations for its hardware, operating system and other softwares installed. With respect to GrafEq:

If computer time is restricted, such as access to machines is limited to one-hour time slots, GrafEq can still be used effectively to plot complicated graphs at high resolutions. At the end of a session, select

halt graphing from the *File* menu, and save the graph in full format. The full graph can be opened at a later time and graphing can resume from where it left off previously.

If disk resources is too scarce for saving a full graph, a graph of interest can usually still be saved in the skeleton format. The skeleton graph can be opened at a later time, although the plotting process must then re-start from scratch.

12.4 Further Reading

For more information on how the graphing process works, see:

Jeffrey Allen Tupper. *Graphing Equations with Generalized Interval Arithmetic*.
M.Sc. Thesis, Department of Computer Science, University of Toronto, January 1996.
<http://www.dgp.toronto.edu/~mooncake/msc.html>

Jeff Tupper. *Reliable Two-Dimensional Graphing Methods
for Mathematical Formulae with Two Free Variables*.
SIGGRAPH 2001 Conference Proceedings, August 2001.
<http://www.dgp.toronto.edu/~mooncake/papers.html>

Appendix A

Easy Buttons

This appendix explains *how to* enter functions, relations, values, and symbols with GrafEq's easy buttons. For explanation of specific functions and relations, refer to the Appendix B, the Functions and Relations appendix (page 83).

Functions, relations, and operations have to be entered in certain formats; they also take varying number of arguments. GrafEq provides the easy buttons as well as the following features to offer support during relation entry:

- Most entries are mathematically intuitive,
- The active constraint field being edited provides hints at the bottom of the field prompting for the next step of action.
- The correctness of any entry can be observed in
 - the relation visual format,
 - the relation tree structure, and
 - the relation graph.

A.1 Algebra Easy Buttons

The *Algebra* easy buttons provides help for entering algebraic functions. The two control buttons on the top row offer options for algebraic power functions, or inverse algebraic power functions. Figure A.1 shows the algebraic easy buttons:

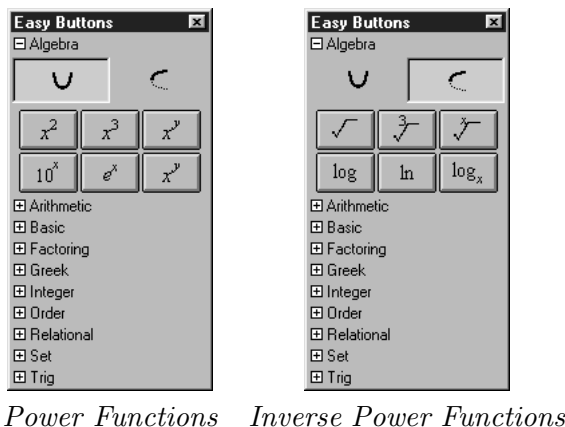
Figure A.1: *Algebra Easy Buttons*

The entities x and y within the easy buttons represent expressions that should be entered *after* the button-click; and the entity a represents arguments that should be entered *prior* to the button-click. Each button is explained as follows:

- To enter a^2 , and a^3 functions, enter an argument first; then click the button;
- To enter 10^x , and e^x functions, click the button first; then enter the power expression (represented by x). For example, to enter “ $e^{33.54}$ ”,
 1. click the e^x button;
 2. enter the power expression (represented by x), which is “33.54” in this example.

Hint: Parentheses would be necessary for power expressions such as x/y , or $2xy$, but not if the power is a single simple term. Experiment with GrafEq to see the differences when these power expressions are entered with, and without parentheses.

- To enter a^x functions, enter the argument first; then click the button; then enter the power term (represented by x). For example, to enter “ $x^2+y^3=5^{2xy}$ ”,
 1. enter “ x ”;
 2. click the a^2 button;
 3. enter “ $+y$ ”;
 4. click the a^3 button;
 5. enter “ $=5$ ”;
 6. click the a^x button; and
 7. enter the expression “ $(2xy)$ ”.

Hint: The same parenthesis rules apply to a^x , 10^x , and e^x , which means that parentheses are necessary for power expressions such as x/y , or $2xy$, but not for single simple terms. Experiment!

- To enter square-root, \log , and \ln functions, click the button first; then enter an argument, which can be a single simple term or an expression enclosed in appropriate parenthesis.

- To enter cube-root functions, click the button first; then enter the argument and finish with a closing parenthesis.
- To enter x th-root y functions, click the button first; then enter the root index expression (represented by x) follow by a comma; then enter an argument expression (represented by y); and finally finish with a closing parenthesis. For example, to enter “5th root of $2x+y$ ”,
 1. click the x th-root y button;
 2. enter the root index expression represented by x , which is “5” in this example,
 3. follow by a comma;
 4. enter the argument expression represented by y , which is “ $2x+y$ ” in this example,
 5. finish with a closing parenthesis.
- To enter $\log_x y$ functions, click the button first; then enter an expression for the log base (represented by x); followed by the argument expression (represented by y). For example, to enter “ $\log_2 x$ ”,
 1. click the $\log_x y$ button;
 2. enter the logarithm base represented by x , which is “2” in this example;
 3. enter the argument represented by y , which is “ x ” in this example.

Hint: Parentheses are not required if the base and the argument are single simple terms or fractions of single simple terms, such as x , y , x/y , 2, 3, or $2/3$. Parentheses are necessary for expressions such as $x+y$, $2xy$, or for two consecutive numeric terms that would otherwise be treated as one number. Try it out!!

Hint: In general, exiting exponent, radical, or logarithmic base is by entering an operation of lower precedence; or if the constraint specification is already complete, by pressing enter, or pressing the tab key to enter the next constraint field. More information about precedence is available in Appendix B, the Functions and Relations appendix (page 83).

A.2 Arithmetic Easy Buttons

The *Arithmetic* easy buttons, as seen in figure A.2, provides help for entering arithmetic operators.



Figure A.2: *Arithmetic Easy Buttons*

To enter or insert an arithmetic operator, just click its button.

, -, and / are all used in between two arguments (infix binary); +, -, ± can be used either in between two arguments, or in front of one argument (prefix unary). Each argument can be a single term or an expression enclosed in appropriate parentheses).

A.3 Basic Easy Buttons

The *Basic* easy buttons, as seen in figure A.3, include six basic mathematical operations and symbols which are frequently used.

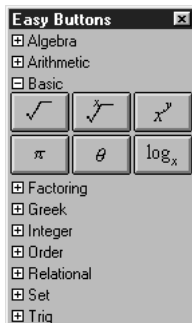

Figure A.3: *Basic Easy Buttons*

Basic easy buttons are also provided in the respective easy button groups to which they logically belong. Explanation of how to enter relevant relations with the buttons are presented again as follows:

- To enter a^x functions, enter the argument first; then click the button; then enter the power term (represented by x). For example, to enter “ 5^{2xy} ”,

1. enter “5”;
2. click the a^x button; and
3. enter the expression “ $(2xy)$ ”.

Hint: Parentheses are necessary for power expressions such as x/y , or $2xy$, but not for single simple terms. When in doubt, parenthesis can always be used.

- To enter square-root functions, click the button first; then enter an argument, which can be a single simple term or an expression enclosed in appropriate parenthesis.
- To enter x th-root y functions, click the button first; then enter the root index expression (represented by x) follow by a comma; then enter an argument expression (represented by y); and finally finish with a closing parenthesis. For example, to enter “5th root of $2x+y$ ”,

1. click the x th-root y button;
2. enter the root index expression represented by x , which is “5” in this example,
3. follow by a comma;
4. enter the argument expression represented by y , which is “ $2x+y$ ” in this example,
5. finish with a closing parenthesis.

- To enter $\log_x y$ functions, click the button first; then enter an expression for the log base (represented by x); followed by the argument expression (represented by y). For example, to enter “ $\log_2 x$ ”,

1. click the $\log_x y$ button;
2. enter the logarithm base represented by x , which is “2” in this example;
3. enter the argument represented by y , which is “ x ” in this example.

Hint: Parentheses are not required if the base and the argument are single simple terms or fractions of single simple terms, such as x , y , x/y , 2, 3, or $2/3$. Parentheses are necessary for expressions such as $x+y$, $2xy$, or for two consecutive numeric terms that would otherwise be treated as one number. Again, when in doubt, parenthesis can always be used.

- To enter or insert π and θ , click the its button.

A.4 Factoring Easy Buttons

The *Factoring* easy buttons, as seen in figure A.4, provides help for entering factoring functions and operators.



Figure A.4: *Factoring Easy Buttons*

- To enter *mod*, *lcm*, *gcd*, and *gamma* functions, click the button, then enter arguments. *gamma* takes one argument, which can be a single term or an expression enclosed in appropriate parentheses. *mod* takes two arguments while *lcm* and *gcd* takes two or more, each separated by a comma, and the last one followed by a closing parenthesis.
- To enter ! functions, enter an argument first, then click the button. The single argument can be a single term or an expression enclosed in appropriate parentheses.

A.5 Greek Easy Buttons

The *Greek* easy buttons provides help for entering Greek characters. The two control buttons on the top row offer options for upper or lower case Greek characters. The three control buttons on the second row offer options for characters groups denoted by the leading characters, namely: set A(from A to I), set ϑ (from ϑ to P), or, set Σ (from Σ to Z); and set α (from α to ι), set φ (from φ to ρ), or, set σ (from σ to ζ).

To enter or insert a greek character, just click its button. Figure A.5 shows the Greek easy buttons:

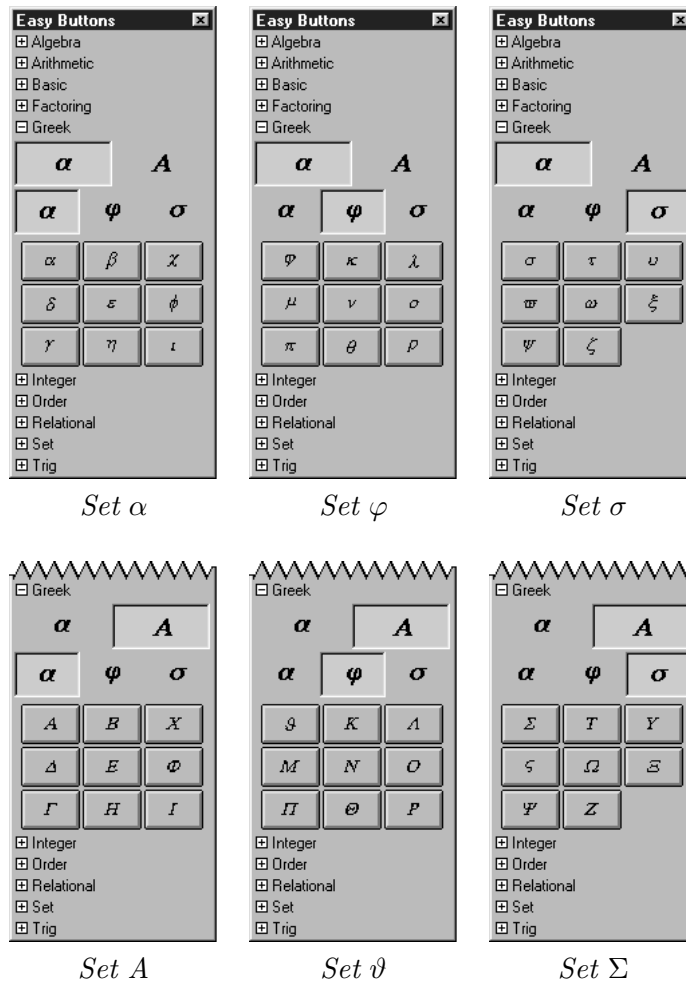

Figure A.5: Greek Easy Buttons - Lower and Uppercase Characters

A.6 Integer Easy Buttons

The integer easy buttons, as seen in figure A.6, provides help for entering integer functions and operators.



Figure A.6: Integer Easy Buttons

- To enter floor and ceiling functions, click the opening button, then enter the argument, then click the closing button. The single argument can be a single term or an expression enclosed in appropriate parentheses.

- To enter round, and trunc functions, click the button first, then enter an arguments. The single argument can be a single term or an expression enclosed in appropriate parentheses.

A.7 Measure Easy Buttons

The *Measure* easy buttons, as seen in figure A.7, provides help for entering magnitude operators.

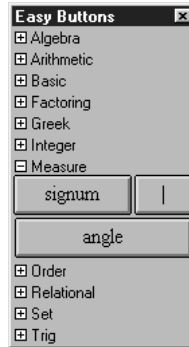

Figure A.7: *Measure Easy Buttons*

- To enter $|x|$ functions, click the button first, then enter an argument, which can be a single term or an expression enclosed in appropriate parentheses, then close by clicking the button again.
- To enter *signum*, and *angle* functions, click the button first, then enter an argument, which can be a single term or an expression enclosed in appropriate parentheses.

A.8 Numbers Easy Buttons

The *Numbers* easy buttons, as seen in figure A.8, provides help for entering numeric digits, the decimal point, and the negative sign.



Figure A.8: *Numbers Easy Buttons*

To enter or insert a number digit, just click on its button. Numbers can be conveniently entered via the computer keyboard; this easy button set is provided for completeness, and is turned off in preferences settings by factory default.

A.9 Order Easy Buttons

The *Order* easy buttons, as seen in figure A.9, provides help for entering maximum and minimum ordering functions:

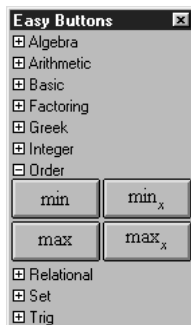

Figure A.9: *Order Easy Buttons*

- Click the ordering buttons first, then enter arguments.
- Min and max return the minimum and maximum respectively, of specified arguments; \min_x and \max_x return the x th smallest and the x th largest respectively, of specified arguments.
- To enter \min and \max functions, click the button first, then enter two or more arguments, separating any two by a comma, and finish with a closing parenthesis after the last argument.
- To enter \min_x and \max_x functions,
 1. click the button first,
 2. enter a positive integer for the base x ,
 3. start the argument list with an opening parenthesis,
 4. enter an appropriate number of arguments, separating any two by a comma,
 5. and finish with a closing parenthesis after the last argument.

Hint: The number of argument should be equal to or larger than the value of x .

A.10 Relational Easy Buttons

The *Relational* easy buttons provides help for entering relational symbols. The two control buttons on the top row offer options for simple relational symbols, or negated relational symbols. Figure A.10 shows the relation easy buttons:

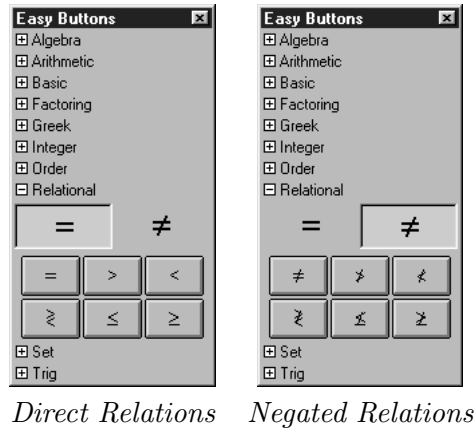
Figure A.10: *Relational Easy Buttons*

To enter or insert a relational symbol, just click its button.
All relational symbols are used between two arguments (infix binary).

A.11 Roman Easy Buttons

The *Roman* easy buttons provides help for entering Roman characters. The two control buttons on the top row offer options for upper or lower case Roman characters. The three control buttons on the second row offer options for characters groups denoted by the leading characters, namely, set A(from A to I), set J(from J to R), or, set S(from S to Z), and set a(from a to i), set j(from j to r), or, set s(from s to z). Figure A.11 shows the Roman easy buttons:

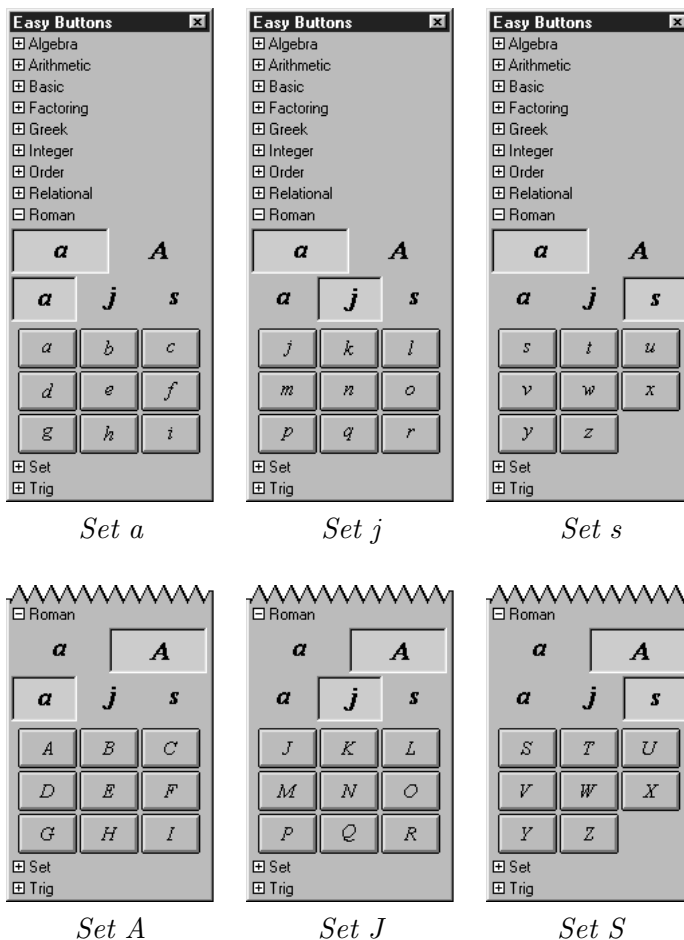

Figure A.11: Roman Easy Buttons - Lower and Uppercase Characters

To enter or insert a Roman character, just click its button.

Roman characters can be conveniently entered via the computer keyboard; this easy button set is provided for completeness, and is turned off in preferences settings by factory default.

A.12 Set (and conditional definition) Easy Buttons

These easy buttons, as seen in figure A.12, provides help for entering set symbols and conditional definitions.



Figure A.12: Set Easy Buttons

- To define a set by listing its elements:
 1. click the open brace button (or enter the open brace from the keyboard),
 2. enter a set element;
 - if it is not the last element,
 - click the comma button (or enter a comma from the keyboard),
 - and enter the next element,
 - and repeat the two above steps until the last element is entered.
 3. finish by clicking the close brace button (or enter the close brace from the keyboard).
- To enter set membership definitions, enter an argument first, click the “is member” or “is not member” button, then enter the set definition.
- To enter conditional definitions,
 1. click the open brace button (or enter the open brace from the keyboard),
 2. enter terms and conditions as follows:
 - (a) enter a term,
 - (b) enter a space, then click the *if* button, then enter a space again,
 - (c) enter a condition term,
 - (d) and repeat the three steps above until all terms and conditions are entered.
 3. finish by clicking the close brace button (or enter the close brace from the keyboard).

An example conditional definition is $y=\{x \text{ if } x>0, 0 \text{ if } x=0, -x \text{ if } x<0\}$

- Pairs of braces, brackets, and parentheses, can all be used to control precedence. Just click pairs of opening and closing buttons accordingly to insert them.

A.13 Trig Easy Buttons

The *Trig* easy buttons provides help for entering various trig functions and relations. The three control buttons on the top row offer options for simple trig functions, inverse trig functions, or inverse trig relations. The four control buttons on the second row offer options for operations groups based on four different conics, namely, circle set, hyperbola set, square set, or diamond sets. Figure A.13 shows the trig easy buttons:

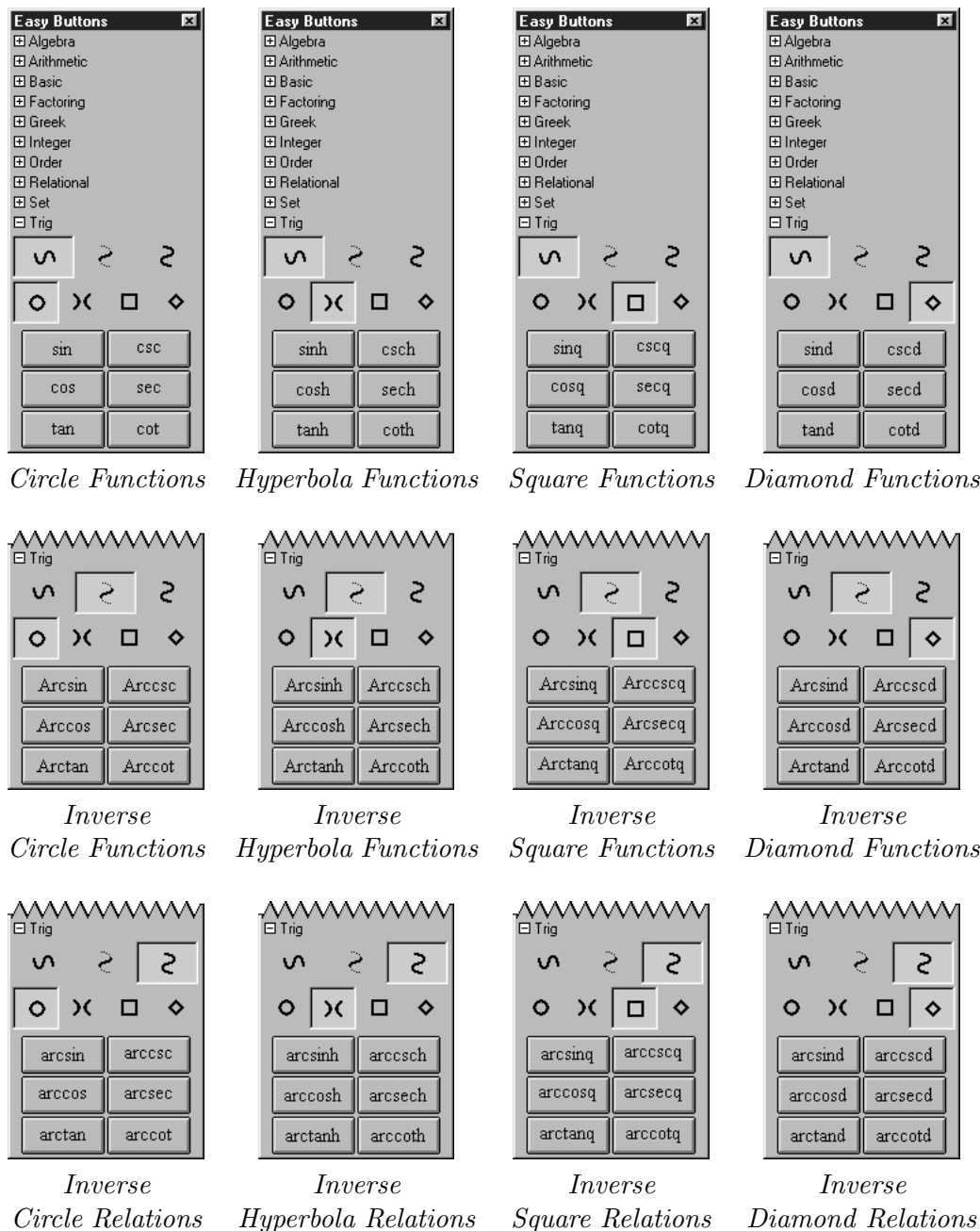

Figure A.13: Trig Easy Buttons

All trig operators are used in front of one argument (prefix binary); so click the button first, then enter the argument, which can be a single simple term or an expression enclosed in appropriate parenthesis.

To conclude this section of the manual, following are some additional hints and tips about the easy button floating window:

- All functions, operations and symbols may also be entered via the keyboard. The key-combinations for special characters and operators are listed in Appendix E, the Keyboard Shortcuts appendix (page 97).

- Easy buttons are provided in an easy button floating window. The display of each group of easy buttons in the floating window can be toggled on or off by clicking the box adjacent to the corresponding set name.
- Easy button groups altogether with the respective headings can be hidden from the easy button floating window, across sessions, by unselecting the respective “Available” checkboxes from the File Preferences window - Algebraic Window - Easy Buttons - Access menu. By factory default, all but *Measure*, *Numbers*, and *Roman* buttons are selected, but a smaller selection may be appropriate for a beginners’ class or a special lesson. For details of the floating window, refer to the Easy Button Floating Window chapter (page 7).
- For details of the easy button floating window, refer to the Easy Button Floating Window chapter (page 7).

Appendix B

Functions and Relations

This appendix explains many interesting functions and relations. They are presented logically in groups which are in similar order as GrafEq's easy button groups. Mathematical symbols not readily available from the standard keys on a keyboard can be entered with easy buttons; for details, refer to the Appendix A, the Easy Buttons appendix (page 69).

Tip: A good way to understand and investigate a function or relation is to graph it with GrafEq!

B.1 Algebraic Functions

- Exponentiation (including a^2 , a^3 , and other simple and complex power functions) each takes one base term, and one power term.

Hint: Besides easy buttons, entry of exponentiation can also be initiated by pressing the up arrow key or the caret key in GrafEq.

- Radical (including sqrt, root(3,x), and other simple and complex root functions) each takes one root index term, and one radical term.
- Logarithm (including log for base 10, lg for base 2, ln for natural logarithm or base e , and other simple and complex logarithm functions) each takes one base term, and argument term.

Hint: Besides easy buttons, entry of logarithm base can also be initiated by pressing the down arrow key in GrafEq.

B.2 Arithmetic Operations

- Addition (+), subtraction (−), and add-and/or-subtract (\pm) can be either infix binary with the operator in between two argument terms, or prefix unary with the operator in front of one argument term.

Hint: Besides the easy button, the \pm symbol can be entered with the Ctrl-+ key combination in GrafEq.

- Multiplication (*) and division (/ or \div) are both infix binary.

Hint: Besides the easy button, the \div symbol can be entered with the Ctrl-/ key combination in GrafEq.

B.3 Factoring Functions

- Modulo (mod) takes two argument terms, and returns the positive remainder of the division of the first argument term by the second argument term.
- Least common multiple (lcm) and greatest common divisor (gcd) each takes two or more argument terms, and are generalized to real valued arguments.
- Gamma (gamma) function is a continuous extension of the factorial function. For any non-negative integer x , $\text{gamma}(x+1)$ is equal to $x!$.
- Factorial (!) is postfix unary with the operator, following one argument term. It is a recursively defined function: for any non-negative integer x , $(x+1)!$ returns $(x+1)x!$, and $0!$ returns 1.

B.4 Integer Functions

Integer functions convert real values to integers. Each function takes one argument.

- Floor ($\lfloor x \rfloor$) returns the closest integer smaller than or equal to the argument value.
Hint: Besides the easy buttons, the floor symbols can be entered with the Ctrl-[and Ctrl-] key combinations in GrafEq.
- Ceiling ($\lceil x \rceil$) returns the closest integer larger than or equal to the argument value.
Hint: Besides the easy buttons, the ceiling symbols can be entered with the Ctrl-{ and Ctrl-} key combinations in GrafEq.
- Round (Round) and round (round) both return the closest integer from the argument value; but if the argument value ends with '.5', such as 4.5, Round would round up and return 5, while round would round down and return 4.
- Trunc (trunc) returns the integer portion of the argument value, by deleting the fractional part. It returns the same value as the floor function for positive argument values; and the same value as the ceiling function for negative argument values.

B.5 Measure Functions/Magnitude Operators

- Absolute Value ($|x|$) takes one argument, and returns the value without the sign.
- Signum (signum) takes one argument, and returns -1 for a negative argument, 1 for a positive argument, and 0 for an argument that equals 0.
- Angle (angle) takes two arguments x and y , and return the angle between the point (x,y) and the x -axis.

B.6 Order Functions

- Minimum (min) and maximum (max) each takes two or more arguments, and returns the smallest, and largest value respectively.

- x th minimum (\min_x) and x th maximum (\max_x) each takes a number of argument equal to or larger than the value of x , where x is a positive integer. \min_x returns the x th smallest, and \max_x returns the x th largest value.

Hint: If x does not evaluate to an integer between 1 and the number of arguments, both functions would be undefined.

B.7 Relational Functions

Equal to ($=$), less than ($<$), greater than ($>$) and other simple and complex, positive and negative relations are all infix binary, with the operator in between two terms.

Hint: Besides easy buttons, less than or equal to can also be entered with the Ctrl-< key combination; greater than or equal to with the Ctrl-> key combination in GrafEq.

B.8 Set and Conditional Functions

- Set element listings are to be enclosed within pairs of braces ($\{\}$), with a comma ($,$) separating every two successive set elements.
- Set membership can be defined with is member (\in) and is not member (\notin).

Hint: Besides easy button, is member of can also be entered with the Ctrl= $=$ key combination in GrafEq.

- Conditional definitions are described within pairs of braces ($\{\}$), with one or more sets of a value term followed by if (if), then the condition. An example is: $y=\{x \text{ if } x \geq 0; -x \text{ if } x < 0\}$

Hint: Pairs of braces, brackets, as well as parentheses can also be used to control precedence.

B.9 Trig Functions and Relations

All trig functions and relations take one argument each.

- Trig functions include circular, hyperbolic, square, and diamond functions.
 - Circular trig functions are based on the circle, and include sine (sin), cosine (cos), tangent (tan), cosecant (csc), secant (sec), and cotangent (cot).
 - Hyperbolic trig functions are based on the hyperbola, and include the six functions of the circular ones, but with an appended “h”. They are sinh, cosh, tanh, csch, sech, and coth.
 - Square trig functions are based on the square, and include the six functions of the circular ones, but with an appended “q”. They are sinq, cosq, tanq, cscq, secq, and cotq.
 - Diamond trig functions are based on the diamond parallelogram, and include the six functions of the circular ones, but with an appended “d”. They are sind, cosd, tand, cscd, secd, and cotd.
- Inverse Trig Functions also include circular, hyperbolic, square, and diamond functions. Each collection has the same trig functions, but with a preceding “Arc”. They include Arcsin, Arccosd, and so on.

- Inverse Trig Relations also include circular, hyperbolic, square, and diamond relations. Each collection has the same trig operations, but with a preceding “arc”. They include arcsin, arccosd, and so on.

To conclude this section of the manual, following are some additional hints and tips about GrafEq functions, relations, and operations:

- Each argument or term can be a simple term or a complex term that can contain any number of functions, operations, and values. Complex terms might need to be enclosed in appropriate/necessary parentheses.
- Degree ($^\circ$), Minute ($'$), and Second ($''$) returns $\pi/180$, $\pi/(180*60)$, and $\pi/(180*60*60)$ respectively.

Hint: $5'33''$ is interpreted as the multiplication product of $5\pi/(180*60)$ and $33\pi/(180*60*60)$.

- Precedence of operations:
 1. Bracket-like operators, such as brackets, parenthesis, braces, floor, ceiling, absolute value, and conditional/piecewise definition
 2. Postfix operators, such as factorial
 3. Exponentiation
 4. Multiplication and division
 5. Prefix operators, such as negation
 6. Addition and subtraction
 7. Comparisons, such as equal-to, less-then, and greater-then
 - Precedence for function application is not clear cut. For example, $\sin 2x$ is parsed as $\sin(2x)$; multiplication has higher precedence than the sine function. However, $\sin x \cos x$ is parsed as $(\sin x)(\cos x)$; multiplication has higher precedence in $\sin 2x$, but has lower precedence in $\sin x \cos x$.
 - The visual mathematics formatting which GrafEq’s algebraic window presents often reflect whether a specification is entered correctly. If in any doubt, parentheses or brackets can always be used.

Tip: The structural tree structured relation description is a new feature introduced in GrafEq 2.04, and can be used for accurate confirmation.

Appendix C

Draw Tools

Draw tools are for inserting labels, explanations, descriptions, and drawings to graph views and pages. They are accessible for pages from the page buddy window. They are accessible for graph views from the view buddy window, by first clicking on the buddy mode pop-up (at the top of the floating window) menu, then selecting *Draw* from the menu.

Draw tool types include:

- a selection tool, for selecting objects;
- an arrow tool, for drawing arrows and lines;
- a box tool, for drawing rectangular boxes;
- a text tool, for writing text annotations; and
- a formula tool, for writing mathematics formula annotations.

The active draw tool is selected by clicking, or pressing down its button in the draw buddy window or the page buddy window. The respective draw tool options and controls would then be presented in a separate *Draw Tools* floating window.

If an object is created or selected, the tool's controls will modify this current object only. If no object is selected, a tool's controls will modify the default settings for that tool, which affect all objects subsequently created.

C.1 The Selection Tool

The selection tool is for selecting an object which can then be moved, edited, or deleted. It is the black cursor button in the draw buddy or the page buddy.

Following are some use instructions for the selection tool:

- At most one object can be selected at a time.
- To select a new object, first ensure that the selection button in the draw buddy or page buddy is pressed down, then click on the new object to select it. Selection is possible when the cursor appears as a hand with a pointing finger.
- When an object is selected, a *Draw Tools* floating window which is associated with the type of the selected object would appear automatically. The selected object can then be edited using the relevant tools provided in that *Draw Tools* floating window.

For details about a draw tool's controls, refer to the manual sections for that tool.

- If no object is selected, no *Draw Tools* floating window will be displayed.
- With selection as the current tool, a selected object can be deselected by:
 - selecting another object,
 - pressing the enter key, or
 - clicking on an area where there are no objects to select.

The object selected with the selection tool can be moved, edited, or deleted. To effectively manipulate objects, note the following attributes:

- An object is automatically selected when it is created.
- Any object can be selected with the selection tool by clicking on the object.
- Control points are found in all selected objects. They characterize the selected object, and denote its limits.
 - For formulae, text, and boxes, control points denote an object's four corner points and four edge midpoints.
 - For arrows, control points denote the arrow's starting (source) and ending (destination) points.
 - Unselected objects do not display any control points.
- Control points are also used for resizing and/or re-orienting objects.
 - For formulae, text, and boxes, a corner point controls its two adjacent edges, while an edge midpoint controls just the one immediate edge.
 - For arrows, control points are for changing the endpoints of the arrow, thus changing the arrow's length or orientation.
 - To use a control point: first place the cursor directly above the control point (the cursor will change into a small triangle pointer), then drag the control point to its new position.
- The selected object can be entirely exposed, on the topmost layer; it can also be partially covered, in a layer underneath other objects.
 - To quickly bring a selected object up to the topmost layer, press the up arrow key once; to quickly bring a selected object down to the bottom layer, press the down arrow key once.
 - To fit an object into a specific layer in between the topmost and the bottom layer, manually move away objects at layers higher than the desired layer, then put the special object on top, then replace any moved objects back.
- To move an object, ensure that it is selected first, place the cursor over the object but away from any control points, then drag the object to its new location. Dragging is possible when the cursor appears as an open (grabbing) hand.
- To delete an object, ensure that it is selected first, then press the del key or the Backspace key once.

C.2 Arrow Tools

The arrow tool is for drawing lines, single-headed arrows, and/or double-headed arrows in graph views or pages. It is the arrow button in the draw buddy and the page buddy.

To insert an arrow, first ensure that the arrow button in the draw buddy or page buddy is pressed down. Bring the mouse to the desired starting point (the source) of the arrow, press and hold down the mouse button dragging the mouse to the desired ending point (the destination) of the arrow. Release the mouse button once the final position is correct.

To resize, re-orient, move, or delete an arrow, refer to the selection tool manual section presented earlier. To customize the appearance of lines and arrows, use arrow tools as presented in figure C.1 and explained following:



Figure C.1: *Arrow tools floating window*

- Source radio buttons on the leftmost column; destination radio buttons, the rightmost. Click one of the source radio buttons to select the source point appearance; click one of the destination radio buttons to select the destination point appearance.
- *Arrowhead Size* pop-up menu
Click on this pop-up menu to open the arrowhead size menu and select a desired size. Different sizes have the same proportion between width and length. The selected size applies to both source and destination ends.
- *Arrowhead Width* pop-up menu
Click on this pop-up menu to access the width pop-up menu, to select a desired width. Different width have the same length. The selected width applies to both source and destination ends.
- *Line Thickness* pop-up menu
Click on this pop-up menu to access the thickness pop-up list, to select a desired thickness. The selected thickness applies to the source, the line, as well as the destination.

C.3 Formula Tool

The Formula tool is for writing formatted mathematical formulae in graph views or pages. It is the “ x^2 ” button in the draw buddy and the page buddy.

To insert a formula, first ensure that the formula button in the draw buddy or page buddy is pressed down. Click the mouse once at the center of where the formula is desired, an easy button floating window will appear to provide help in formula entry, and the formula can be entered. To resize, move, or delete a formula, refer to the selection tool manual section presented earlier. To customize the appearance of formulae, use formula tools as presented in figure C.2 and explained following:

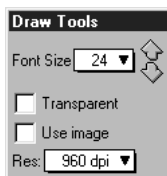

Figure C.2: *Formula Tools Floating Window*

- *Font Size* pop-up menu and finetune arrows
Click on the pop-up menu to open the font size list and select a desired size. Each click on the finetune up arrow increases the font size by 1; each click on the finetune down arrow reduces it by 1.
- *Transparent* background checkbox
Select this option to use a transparent background for the formula box. De-select it to use an opaque white background.
- *Use bitmap* checkbox
Select this option to use bitmap font.
- Resolution pop-up menu
Click on this pop-up menu to open the resolution menu and select a desired resolution.

Hint: The size of the formula box is determined by the length of the formula and the font size selected.

C.4 Text Tool

The text tool is for writing text in graph views or pages. It is the “A” button in the draw buddy and the page buddy.

To insert a text object, first ensure that the text button in the draw buddy or page buddy is pressed down. Click the mouse once at the center of where the text is desired, A text editing window, as seen in figure C.3, will appear automatically for entering text contents:

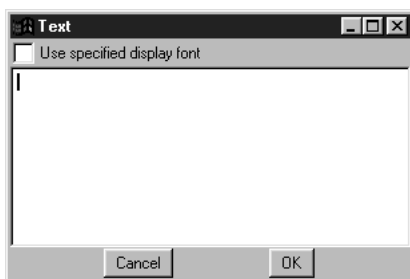
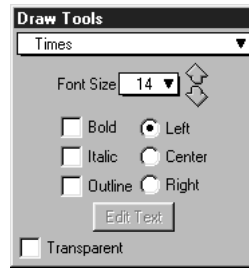

Figure C.3: *A Text Editing Window*

- The text region is for entering and displaying the text.
- The *Cancel* button is for aborting text writing, closing the text editing window.
- The *Ok* button for is completing text editing, closing the text editing window, and inserting the text to the graph view or page.

To resize, move, or delete a text object, refer to the selection tool manual section presented earlier. To customize the appearance of text objects, use text tools as presented in figure C.4 and explained following:

Figure C.4: *Text Tools Floating Window*

- **Font type pop-up menu**
Click on this pop-up menu to open the font type list and select a desired font.
- **Font Size pop-up menu and finetune arrows**
Click on this pop-up menu to open the font size menu and select a desired size. Each click on the finetune up arrow increases the font size by 1; each click on the finetune down arrow reduces it by 1.
- **Text format checkboxes for *Bold*, *Italic*, and *Outline* fonts**
For each of the three text format settings, click to toggle between the selected and unselected states.
- **Text alignment radio buttons for *Left*, *Center*, and *Right* alignment**
Select one of the three options by clicking its radio button.
- ***Edit Text* button**
Click on this edit button to return to the text editing window, to change the text contents. This button is greyed out (inactive) when the text tool is first accessed and a text object has not yet been inserted.
- ***Transparent* background checkbox**
Select this option to use a transparent background for the text box. De-select it to use an opaque white background.

Hint: The size of the text box is determined by the length of the text and the font size selected.

C.5 Box Tools

The box tool is for drawing rectangle boxes in graph views or pages. It is the rectangle box button in the draw buddy and the page buddy.

To insert a box object, first ensure that the box button in the draw buddy or page buddy is pressed down. Bring the mouse to one corner of the desired box, press and hold down the mouse button while dragging the mouse to the opposite corner of the box. Release the mouse button once the final position is correct.

To resize, move, or delete a box object, refer to the selection tool manual section presented earlier. To customize the appearance of boxes, use box tools as presented in figure C.5 and explained following:

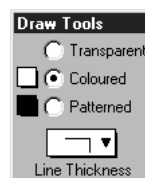
Figure C.5: *Box Tools Floating Window*

- Box background radio buttons for *Transparent*, *Colour*, and *Pattern* background
Select one of the three options by clicking its radio button.
 - If the colour option is selected, the background colour is to be selected with the colour pop-up menu adjacent to the *Colour* radio button.
 - If the pattern option is selected, the background pattern is to be selected with the pattern pop-up menu adjacent to the *Pattern* radio button.
- *Line Thickness* pop-up menu
Click on this pop-up menu to open the line thickness menu and select a desired thickness for the border of the box.

Appendix D

Values and Variables

There are three main groups of values and variables in GrafEq as explained following:

D.1 Numbers

Numbers are formed from the ten numeric digits (0 to 9), the decimal point, and the negation sign. Numbers, or to be precise, digits, can only be numeric values, and cannot be used as variables.

Numbers can be entered via the computer keyboard, the numeric key pad, or the easy button floating window.

Tip: Infinity (∞) is a constant, and can be entered by pressing Ctrl-8 in GrafEq.

D.2 Roman Letters

All Roman letters **except** e can be used as variables or constants. e is a predefined constant in GrafEq, equals 2.7182818284590452..., and is the base of natural logarithms. GrafEq is case sensitive, so upper-case and lower-case letters are considered different and unique; x and X are not the same.

Roman letters can be entered via the computer keyboard, or the easy button floating window.

D.3 Greek Letters

All Greek letters **except** π can be used as variables or constants. π is a predefined constant in GrafEq, equals 3.1415926535897932..., and is a half circle's angle in radian measure. GrafEq is case sensitive, so upper-case and lower-case letters are not the same; ω and Ω are two different variables.

Greek characters can be entered via the easy button floating window, by typing in their name, or by using the keyboard key combinations listed in figure D.1. For example, “ α ” may be entered by clicking on the appropriate easy button, by typing “alpha”, or by pressing Ctrl-Alt-a.

Alpha	A	Ctrl-Alt-A	α	Ctrl-Alt-a
Beta	B	Ctrl-Alt-B	β	Ctrl-Alt-b
Chi	X	Ctrl-Alt-C	χ	Ctrl-Alt-c
Delta	Δ	Ctrl-Alt-D	δ	Ctrl-Alt-d
Epsilon	E	Ctrl-Alt-E	ϵ	Ctrl-Alt-e
Phi	Φ	Ctrl-Alt-F	ϕ	Ctrl-Alt-f
Gamma	Γ	Ctrl-Alt-G	γ	Ctrl-Alt-g
Eta	H	Ctrl-Alt-H	η	Ctrl-Alt-h
Iota	I	Ctrl-Alt-I	ι	Ctrl-Alt-i
Theta Variant	ϑ	Ctrl-Alt-J		
Phi Variant			φ	Ctrl-Alt-j
Kappa	K	Ctrl-Alt-K	κ	Ctrl-Alt-k
Lambda	Λ	Ctrl-Alt-L	λ	Ctrl-Alt-l
Mu	M	Ctrl-Alt-M	μ	Ctrl-Alt-m
Nu	N	Ctrl-Alt-N	ν	Ctrl-Alt-n
Omicron	O	Ctrl-Alt-O	o	Ctrl-Alt-o
Pi	Π	Ctrl-Alt-P	π	Ctrl-Alt-p
Theta	Θ	Ctrl-Alt-Q	θ	Ctrl-Alt-q
Rho	P	Ctrl-Alt-R	ρ	Ctrl-Alt-r
Sigma	Σ	Ctrl-Alt-S	σ	Ctrl-Alt-s
Tau	T	Ctrl-Alt-T	τ	Ctrl-Alt-t
Upsilon	Y	Ctrl-Alt-U	v	Ctrl-Alt-u
Sigma Variant	ς	Ctrl-Alt-V		
Pi Variant			ϖ	Ctrl-Alt-v
Omega	Ω	Ctrl-Alt-W	ω	Ctrl-Alt-w
Xi	Ξ	Ctrl-Alt-X	ξ	Ctrl-Alt-x
Psi	Ψ	Ctrl-Alt-Y	ψ	Ctrl-Alt-y
Zeta	Z	Ctrl-Alt-Z	ζ	Ctrl-Alt-z

Figure D.1: *Greek Alphabet and corresponding input key combinations*

D.4 Sets

Sets can be discrete or continuous.

A discrete set contains elements listed within a pair of braces.

A continuous set can either contain open ranges described within a pair of parentheses, or closed ranges described within a pair of square brackets.

To conclude this section of the manual, following are some additional hints and tips about GrafEq values:

- GrafEq relations can be specified in a wide latitude:
 - Virtually all alphabetical characters are acceptable as variables.
 - At the Create View window, any alphabetical characters entered in a relation can be specified as domain and range variables. And x , y , r , and θ are always available as possible variables.
 - For cartesian (rectangular) graphs, domain (horizontal axis) and range (vertical axis) variables default to x and y ; for polar graphs, θ and r .

- In both cartesian and polar graphs, r defaults to the distance from the origin, and θ to the position angle in radians.
- Some characters are reserved in GrafEq to be values, therefore, they cannot be used to represent variables. These values include: π , e , ∞ , and all numeric digits.
- Variable names must be atomic; xy means two variables, and cannot be used as one variable name.

Appendix E

Keyboard Shortcuts

E.1 File Menu

Ctrl-N	New Graph
Ctrl-O	Open
Ctrl-W	Close Window
Ctrl-S	Save
Ctrl-.	Halt Graphing
Ctrl-Q	Quit

Hint: Either upper-case or lower-case characters can be used.

E.2 Edit Menu

Ctrl-Z	Undo
Ctrl-X	Cut
Ctrl-C	Copy
Ctrl-V	Paste
Ctrl-A	Select All

E.3 Graph Menu

Ctrl-R	New Relation
--------	--------------

E.4 Mathematics Symbols and Formats

↓	subscript
or _	
↑	superscript
or ^	
Ctrl-Alt-=	∈
Ctrl-Alt-/	÷
Ctrl-Alt-[[
Ctrl-Alt-]]
Ctrl-Alt-{	[
Ctrl-Alt-}]
Ctrl-Alt-'	°

Negative relations, such as $\not\geq$, $\not\in$, etc., is entered by following the positive relation with an “/” or an “!”.

A complete listing of Greek characters with corresponding input key combinations is provided in Appendix D, the Values and Variables appendix (page 93).

E.5 View Buddy

C	Colour	Ctrl-Alt-B Ctrl-Alt-C Ctrl-Alt-T Ctrl-Alt-#	Blending (toggle on/off) Colour (toggle on/off) Tick (toggle on/off) Activate Relation Number# (toggle on/off)
D	Draw	Ctrl-Alt-↑ Ctrl-Alt-↓ Ctrl-Alt-spacebar Ctrl-Alt-Backspace or Ctrl-Alt-Delete	move up one layer move down one layer Revert to previous tool erase current object
I	Information	Ctrl-Alt-# Ctrl-Alt-0 Ctrl-Alt-S	Show Relation Number# Show Totals Show work (toggle on/off)
T	Ticks		
Z	Zoom	Ctrl-Alt-click Ctrl-Alt-→ or Ctrl-Alt-↑ Ctrl-Alt-← or Ctrl-Alt-↓ Shift-→ Shift-↑ Shift-← Shift-↓	override “Keep this view...” option enlarge zoom box, both width and length shrink zoom box, both width and length accelerated zoom box widening accelerated zoom box lengthening accelerated zoom box narrowing accelerated zoom box shortening
1	1-Point	mouse click mouse drag → ↑ ← ↓	jump to the curve ride the curve move right 1 pixel precisely move up 1 pixel precisely move left 1 pixel precisely move down 1 pixel precisely
2	2-Point	spacebar A B	interchange points A and B set cursor to point A set cursor to point B

Tutorial I

A Beginner's Guided Tour

In this exercise, we will overview GrafEq's functionality. While the many screen-shots and pictures serve as a pleasant introduction to general users, the step-by-step explanations will help the novice students follow through.

- For a general description for the GrafEq program, visit the on-line description page at <http://www.peda.com/gr>
- For an overview of the program's functionalities, visit the on-line specifications page at <http://www.peda.com/g>
- This tutorial is based on GrafEq 2.05; users of other versions of GrafEq might need to adjust some steps for any differences in the user interface.

I.1 To launch the program

1. Double-click on the GrafEq icon, as seen in figure I.1 following:



Figure I.1: *The GrafEq icon*

2. A splash screen appears, which gradually reveals the GrafEq title screen, as seen in figure I.2 following. Press the space bar once to clarify the splash screen, and once more to remove it.

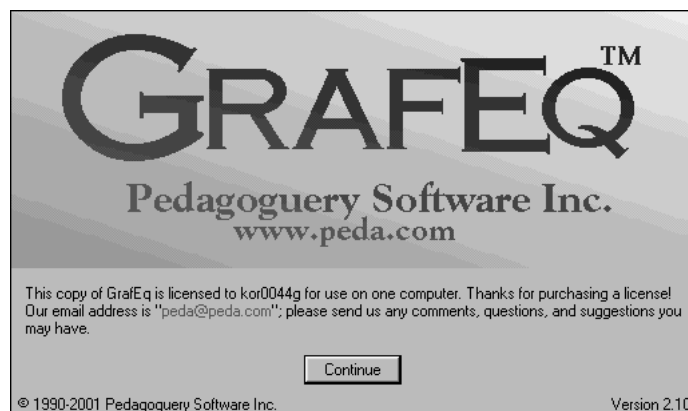

Figure I.2: *The GrafEq logo*

3. The *Relation #1* algebraic window then opens automatically, as seen in figure I.3 following:

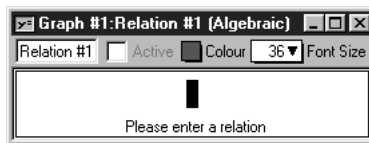

Figure I.3: *An Algebraic Relation Window*

I.2 To enter a relation

1. Ensure that the caps lock key is not depressed.
2. Follow the step sequence, which will be provided, to enter the relation as seen in figure I.4 following:

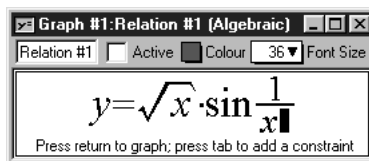

Figure I.4: $y = \sqrt{x} \sin 1/x$

The necessary step sequence is as follows (Refer to the hints immediately following regarding easy buttons and prompts.):

- (a) Type in “y=”;
- (b) Click the $\sqrt{\quad}$ easy button;
- (c) Type in “x”, then “)””, noting the prompt at the bottom of the relation window, that says “Press) to finish the term”;
- (d) Type in “sin1/x”.

Some general hints about entering relation specifications:

- Use the keyboard to enter letters, digits, brackets, and simple symbols such as +, −, *, /, !, >, <, =, ...
- Use easy buttons to enter special characters and operators, such as algebraic powers and roots. Figure I.5 following shows the easy button floating window:

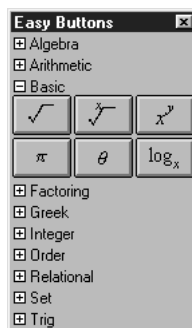

Figure I.5: *Easy Button Floating Window*

- The relation window also displays a prompt message to guide the user. In an empty relation window, as in figure I.5, the help message prompts the user to enter a relation. Other appropriate messages appear at different stages of relation input.
 - The relation window parses entries as a relation specification is being entered, and displays them in standard mathematics format. The sequence of keyboard keys pressed can be revealed by moving the cursor from the end of the entry line to the left.
 - To make changes to the relation, or correct typing mistakes:
 - (a) position the cursor, with the mouse or the left and right arrow keys, to where changes are to be made; (Any relation portions now behind the cursor would become unformatted, as a sequence of keyboard entries; don't worry about them, they will become formatted again when relation entry is completed, or when the cursor is placed back to the end of the entry line.)
 - (b) press the backspace key to erase the character *to the left of* the cursor, and press the del key to erase the character *to the right of* the cursor;
3. The prompt message at the bottom of the window now states "Press return to graph..." Press return now. The Create View window will then appear. Figure I.6 following is the create view window:

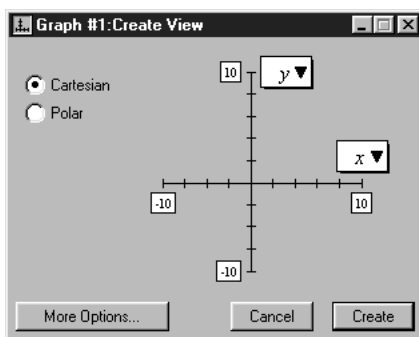

Figure I.6: *The Create View Window*

I.3 To specify a viewport

1. GrafEq can plot both Cartesian and Polar graphs, and will automatically set the default mode according to the relation entered. The graph mode can be changed by clicking its radial button. Since we have entered Relation #1 as a rectangular relation, Cartesian mode is active (by default) in our Create View window, and we will not change that.
2. We will not change the default domain (horizontal) and range (vertical) bounds, but any of them can be changed by:
 - (a) clicking on the box of the bound to be changed; then
 - (b) editing the number in the box; and
 - (c) repeating the steps for any other bounds to be changed.

I.4 To create a graph

1. Create the specified view by clicking the Create button, or simply pressing return as the Create button is the default button. (The thick border around the Create button denotes that it is the default button.) The graph view and an accompanying view buddy floating window appear as in figure I.7 following:

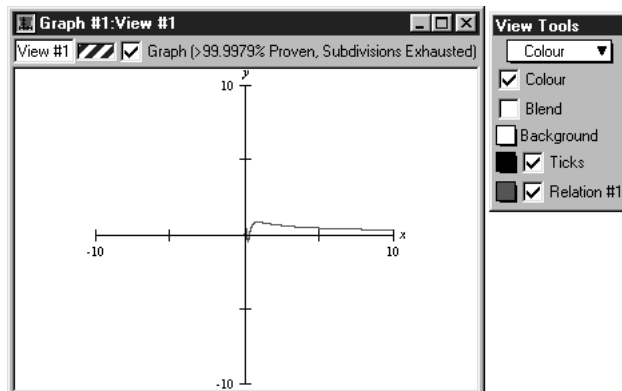

Figure I.7: Graph view of $y = \sqrt{x} \sin 1/x$, and the view buddy

I.5 To apply or remove axes and scales

Figure I.7 shows axes and scales applied to the graph; the steps required to remove or apply them are as follows:

1. Go to the view buddy, click and hold down the mouse on the mode pop-up menu on the top of the floating window; a pull down list appears.
2. Drag the mouse down the list to Ticks, then release the mouse to enter Ticks mode.
3. Click on each of the four buttons in turn to see the different ticks. Figure I.7 uses the second button.
4. The Show Ticks checkbox on top of the buttons is selected. To hide the ticks, click on the checkbox once to toggle ticks inactive. (One more click and the ticks will be toggled active, into the last state selected.)

I.6 To alter the viewport region by zooming

The graph presents a good overview of the relation over the domain and range of $[-10, 10]$. But the interesting portion seems to be a smaller region around the origin. Although we could have created a view with narrower bounds in the Create View window, it is now more convenient for us to change the viewport region with GrafEq's zoom feature.

1. Return to the view buddy, and enter zoom mode by selecting Zoom from the mode pop-up menu at the top of the floating window.
2. The Zoom-Out button is on the view buddy now, but there is not a button for zooming in, since we have to specify the region to be zoomed into.
3. Place the mouse cursor within the graph view; a zoom box will appear.
4. Place the zoom box at the graph's interesting portion, close to the origin, as seen in figure I.8 following:

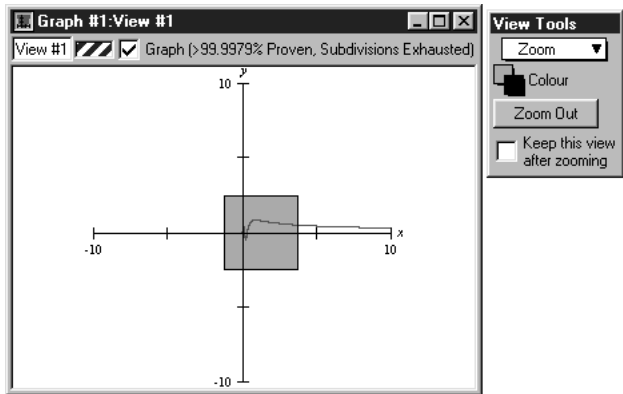

Figure I.8: *Zooming into a graph’s interesting area, with the zoom buddy*

5. Click once to see the selected region, as View #2.
6. Zoom in to the center once again, to create View #3, as seen in figure I.9 following:

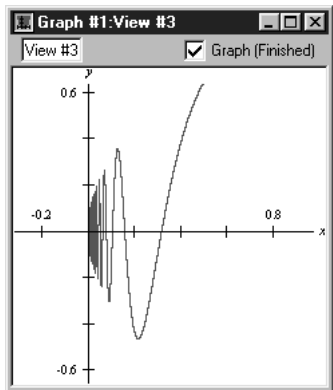

Figure I.9: *A good view of the graph’s interesting area*

I.7 To edit a relation

We will edit the relation, from $y = \sqrt{x} \sin \frac{1}{x}$ to $y = x^2 \sin x^2$.

1. Bring the relation window back up front, to be the active window: If some part of the window is visible, click on it once. Alternatively, go to GrafEq’s top Graph menu, drag the mouse down to Relation #1(Algebraic), and release the mouse to select the algebraic window for Relation #1.

Hint: The relation window appears, but not the prompt message or the easy button floating window. But the Active box in the relation window is selected, and the graph of Relation #1 is shown in the View #3 window.

2. Click once on the relation, to invoke its edit mode.

Hint: The prompt message appears in the relation window and the easy button floating window appears next to the relation window. But the Active box in the relation window is cleared, and the graph of Relation #1 is not shown in the View #3 window.

3. Place the cursor just in front of “sin”, as seen in figure I.10 following:

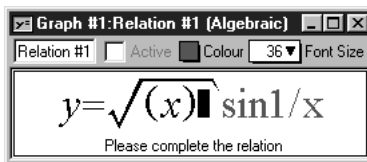
Figure I.10: *Relation #1 being edited*

Tip: Move the cursor by clicking the mouse in the area, or by repeatedly pressing the left arrow key.

Hint: The relation portion behind the cursor becomes unformatted. Don't worry about it; it will be automatically reformatted as they pass to the left side of the cursor.

4. Erase the \sqrt{x} term by either:
 - highlight the term with the mouse and cursor, then press the del key, or
 - press the backspace key until the term is removed.
5. Enter x^2 as follows:
 - (a) Type in x from the keyboard;
 - (b) Go to the easy button floating window, and click the box adjacent to the algebra easy button set to open it;
 - (c) Click the a^2 button once, and the relation window will look like figure I.11 following:

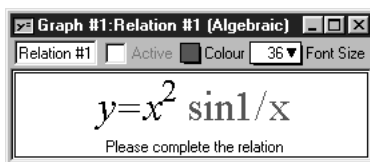
Figure I.11: *Relation #1 edited*

6. Move the cursor to the rightmost end of the relation, and see that the entire relation becomes formatted again, by:
 - clicking the mouse there, or
 - repeatedly pressing the right arrow key until the cursor is there, or
 - holding down the control key and pressing the right arrow key once.
7. Press the delete key three times to remove the $1/x$ term.
8. Enter x^2 one more time to complete relation editing, as seen in figure I.12 following:

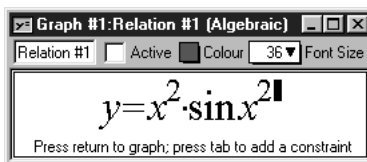
Figure I.12: *Relation #1 edited*

9. Press return to see the new graph plotted in the View #3 window.

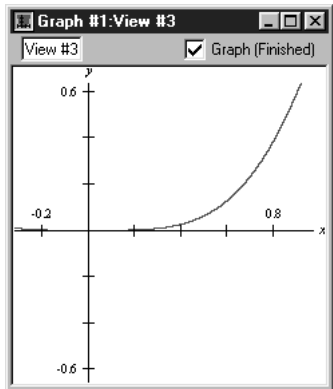

Figure I.13: Graph of the edited Relation #1

10. The new graph above does not look very interesting. But note that the scales show very small numbers, and remember that we had zoomed in twice to produce View #3; we will now zoom back out to take a look at the “bigger picture”.
11. Return to the zoom buddy, referring to the steps described earlier when altering the viewport region, press the *Zoom Out* button a few times. The result of zooming out is intriguing. The following picture, View #7, is obtained after zooming out four times.

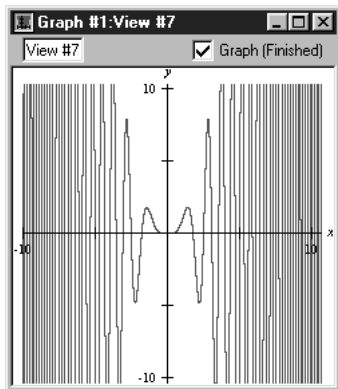

Figure I.14: Graph of the edited Relation #1 after four zoom-outs

I.8 To use constraints in defining a relation

Note that the graph in figure I.14 is much simpler where x is small (less than three). We will now produce a simple graph whose domain is $[0,3]$. We have learned that:

- we can define the bounds in the Create View window, and that
- we can use the zoom feature of GrafEq.

Now we will use constraints in defining a relation.

1. Bring the relation window back to the foremost and invoke its edit mode (refer to the steps described earlier when editing a relation).
2. The prompt message at the bottom of the window states “...press tab to add a constraint.”. Press the tab key now.

3. Enter the constraint " $0 < x < 3$ ", as seen in figure I.15 following:

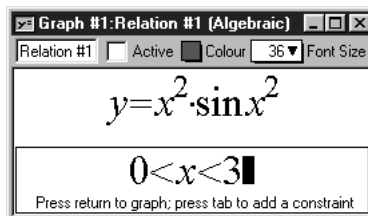

Figure I.15: *Relation #1 with second constraint*

4. Press return for the resulting graph, as seen in figure I.16 following:

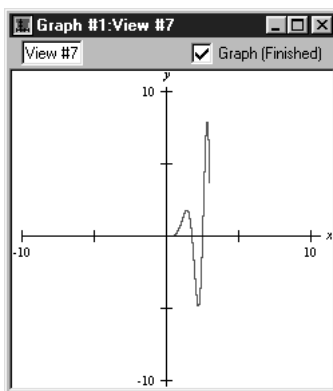

Figure I.16: *Graph of Relation #1 with two constraints*

Congratulations! You have completed the first part of this walk-through exercise! Before you continue on to the next section of the exercise, it is good practice to close your current graph, to free up the computer's memory and screen space. To close your graph:

1. press the mouse button on the *File* menu, then
2. drag the mouse down the pull-down menu to *Close Graph*, and release the button to close your graph.

Graphs may also be saved, for future re-use. A later tour will discuss saving graphs in the various formats supported by GrafEq.

In this section, we will try out graphing multiple relations on the same graph, and a few other features of GrafEq.

I.9 To plot simultaneous systems

1. Under the File menu select New Graph, to get a new relation window.
2. Enter Relation #1 as seen in figure I.17 following, (with the help of the easy buttons for square operations):

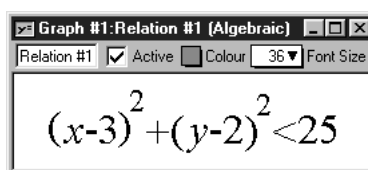

Figure I.17: *Relation #1 for the simultaneous system*

3. Press return after Relation #1 is entered correctly, to get to the Create View Window.
4. The default settings are fine, so press return or click on Create to create a graph.
5. Under the Graph menu, select New Relation, to get another relation window (entitled Relation #2).
6. Enter the second relation, referring to figure I.18 following, then press return.

$$\frac{(x+1)^2}{10} + \frac{(y-5)^2}{25} < 1$$

Figure I.18: *Relation #2 for the simultaneous system*

7. Open another relation window (entitled Relation #3), by selecting New Relation under the Graph menu.
8. According to figure I.19 following, enter the first constraint of the relation, press Tab, then enter the second constraint of the relation:

$$y < -x + 3$$

$$x > -1$$

Figure I.19: *Relation #3 for the simultaneous system*

9. Press return; your graph now shows all three relations in three different colours, layered with Relation #1 at the bottom, then Relation #2, and finally Relation #3 on top, as seen in figure I.20 following:

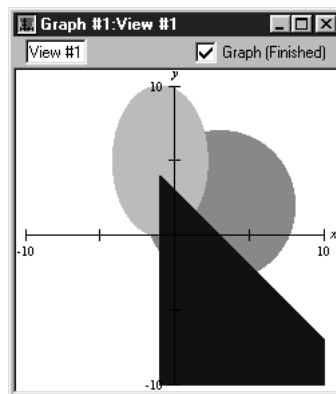

Figure I.20: *Graph of the simultaneous system*

I.10 To blend graphs of simultaneous systems

1. Return to the view buddy, and return to colour mode by selecting Colour from the mode pop-up menu on the top of the floating window.
2. Click to select the Blend checkbox. The graphs for the simultaneous systems become blended, revealing individual graphs and intersections of the simultaneous system, as seen in figure I.21 following:

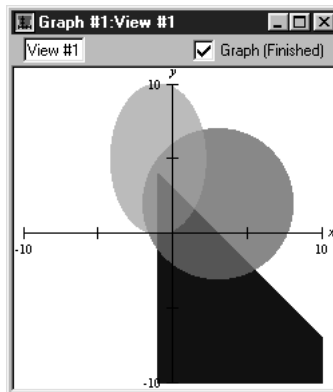

Figure I.21: *Blended graph of the simultaneous system*

I.11 To determine a point's coordinates

1. Return to the view buddy, and enter One Point mode by selecting One Point from the mode pop-up menu on the top of the floating window.
2. Place the mouse close to an intersection point on the graph; pin down the point with the help of the magnified view on the view buddy, as seen following:

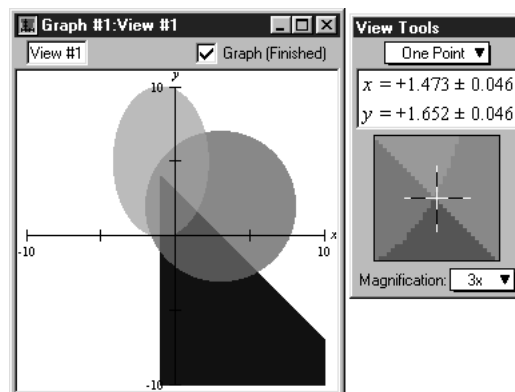

Figure I.22: *Pin down an intersection point with the one point view buddy*

3. Read the coordinates of the point from the view buddy.

I.12 To change the colours of the graphs

1. Access the colour mode view buddy again.

2. Click on the colour box of Relation #1. When the colour panel appears, drag the highlight box to choose another colour.
3. Repeat the process to choose colours for any other relations.

I.13 To determine distances between points

1. Access the Two Point mode of the view buddy. A line segment AB appears on the graph.
2. Use the mouse to drag points A and B to the two ends of the distance to be measured. See figure I.23 following as an example:

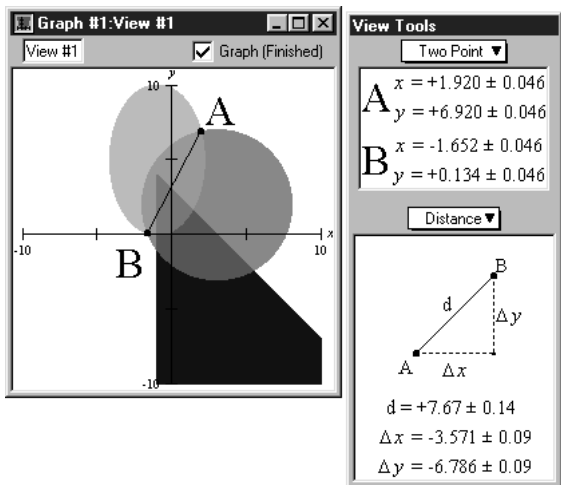

Figure I.23: Measure distance between two points with the two point view buddy

3. Read the distances from the view buddy.

Congratulations! You have completed this introductory tour and experienced the basics of GrafEq. As a reward for completing the tour, graph the relation in figure I.24 following:

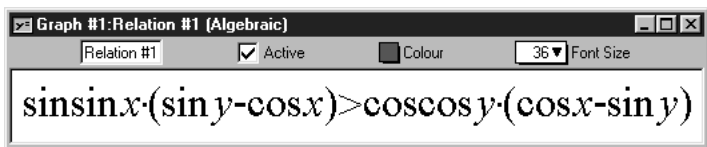

Figure I.24: Reward Relation

Many other features remain to be explored, such as:

- copying and pasting relations and graphs,
- making pages for printing,
- saving graphs to disk,
- using custom ticks,
- using one-key short-cuts, and

- customizing GrafEq for subsequent sessions.

Refer to the manual for full details of GrafEq's functionality; the appendices provide a useful summary and reference. Pedagogy Software will be placing additional tours online at

<http://www.peda.com/grafeq/tutorials.html>,

and with the manual.

Tutorial II

An Enrichment Exercise

In this exercise, we will examine the approximation of the sine function with the McLaurin polynomial. In particular, we will discuss the following question:

- How many terms of the McLaurin series are required to provide an approximation for the sine function? (The McLaurin series for the sine function is $x - \frac{x^3}{3!} + \frac{x^5}{5!} - \frac{x^7}{7!} + \frac{x^9}{9!} - \frac{x^{11}}{11!} + \dots$.)

From the form of the McLaurin series, we can deduce that, ultimately, each successive term of the series brings us closer to the limiting value, on alternate sides. We will take a finite prefix of the McLaurin series as an approximation to the sine function: the more terms we take, the closer the approximation. Our question is: How many terms would be required?

II.1 Plot the sine function and the McLaurin polynomial simultaneously

To visualize and better understand the situation, we will plot the sine function and the McLaurin polynomial simultaneously.

1. Launch GrafEq by double clicking its icon.
2. Click on the title splash screen to proceed - the screen will disappear, and the Graph #1 Relation #1 input window will open automatically.
3. Enter the sine function relation in the relation input window, as in figure II.1 following:

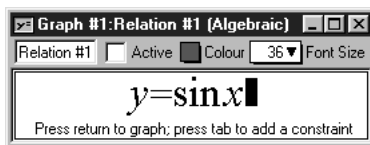
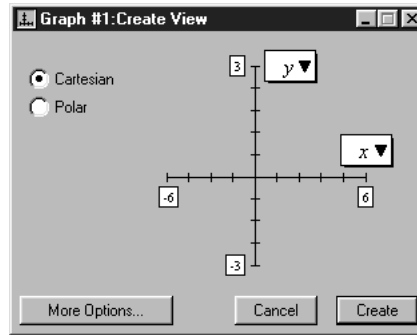
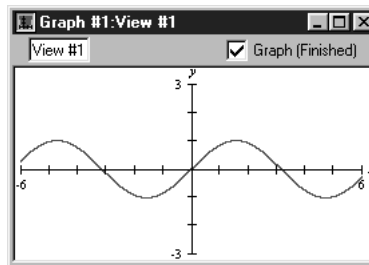

Figure II.1: *The sine function relation*

4. Go on to the Create View window by pressing enter from within the relation window.
5. The Create View window will appear; the default mode (Cartesian) is fine, but the bounds of the axes can be adjusted to obtain a more relevant and focused view of $(-6, 6)$ by $(-3, 3)$, as seen in figure II.2 following:

Figure II.2: *Default view bounds changed*

- For the y -axis bounds:
 - click on the upper bound box and change 10 to 3; and
 - click on the lower bound box and change -10 to -3 .
 - For the x -axis bounds:
 - click on the upper bound box and change 10 to 6; and
 - click on the lower bound box and change -10 to -6 .
6. Click on the Create button; GrafEq will plot the sine graph as in figure II.3 following:

Figure II.3: *The sine graph*

7. Now open a new relation input window to enter the McLaurin polynomial relation.
- (a) Choose Graph from the GrafEq main menu; then
 - (b) choose New Relation.
8. In the Relation #2 input window, enter the 3-term McLaurin polynomial relation for the sine function, by typing in “ $y=x-x^3/3!+x^5/5!$ ”. The entry will be formatted, as seen in figure II.4 following:

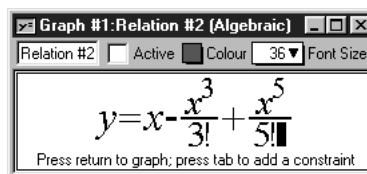
Figure II.4: *The McLaurin polynomial relation*

9. Press enter, GrafEq will display both relations simultaneously.

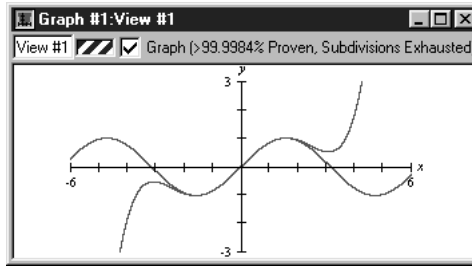

Figure II.5: *The sine and Maclaurin graph*

OBSERVATIONS: The 3-term Maclaurin polynomial

- *approximates the sine function quite accurately within the domain $-2 \leq x \leq 2$; but*
- *is inaccurate for approximating the sine function beyond this domain.*

Thus, for a given Maclaurin polynomial, the accuracy of approximation of the sine function depends primarily on the chosen value of the variable x .

II.2 Add more terms to the Maclaurin series

Next we will look at how adding more terms to the Maclaurin series helps the approximation.

1. Double click on the Relation #2 input window, and add a fourth term to the Maclaurin series as in figure II.6 following:

Figure II.6: *A 4th-term added to the Maclaurin polynomial*

2. Press enter and see from the graph, as in figure II.7 following, that the fourth term of the Maclaurin series extends the approximation domain from $(-2,2)$ to $(-3,3)$.

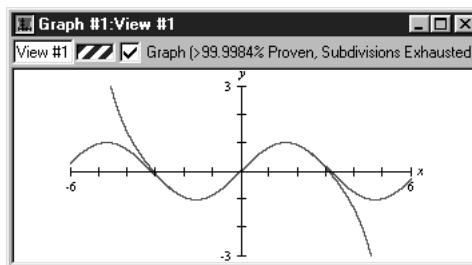

Figure II.7: *Approximation domain extended from $(-2,2)$ to $(-3,3)$*

3. To see the effects of adding more terms to the Maclaurin series, repeat the steps as described above.

REVELATIONS: With each term added, the domain of approximation is further extended. Nevertheless, rather than adding many terms to the Maclaurin series, we will take a second look at the sine function and its approximation; note that

- *The sine curve is periodic; a single period is sufficient to replicate the entire curve.*
- *It has odd symmetry about $x=0$, and even symmetry about $x=\pi/2$; its entirety can actually be determined from just one quarter of a period, from 0 to $\pi/2$.*
- *Therefore, we do not need to approximate the sine function over its complete domain; rather, we only need an accurate approximation over the domain of $(0,\pi/2)$.*
- *It can be proved that the error of McLaurin approximation for the sine curve increases as the magnitude of x increases. Within the domain of $(0,\pi/2)$, the maximum error is at $\pi/2$.*

With such understanding, we can now rephrase our question as: How many terms of the McLaurin series are required to provide an approximation for the sine function at $x=\pi/2$?

II.3 Find the error of approximation

Although the graphs we have seen of the sine function and McLaurin polynomial seem to coincide at $x=\pi/2$, a closer look with GrafEq will help us see that it is actually an approximation.

1. We will first introduce some custom ticks, on the x -axis, in multiples of $\pi/2$:
 - (a) Choose Graph from the GrafEq main menu; then, choose New Custom Ticks.
 - (b) When the system asks if you want preformatted ticks, click the Yes button.
 - (c) Then, check the option for “multiples of $\pi/2$ along x -axis”, and the option for “Excluding $x=0$ ”; the custom ticks window will appear as in figure II.8 following:

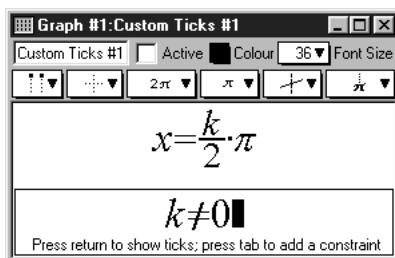

Figure II.8: Custom ticks in multiples of $\pi/2$

- (d) Finally, click the Create button to introduce the ticks to the graph, as seen in figure II.9 following:

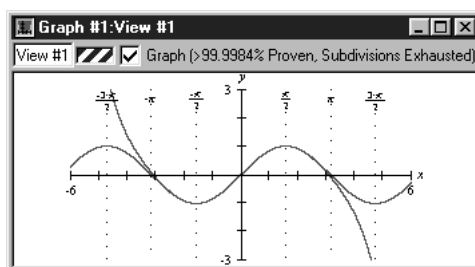

Figure II.9: Custom ticks introduced to graph

2. Next, we will zoom way in to find the approximation error:
 - (a) Return to the view buddy, and enter Zoom mode by selecting Zoom from the mode pop-up menu on the top of the floating window.

- (b) Since we have to zoom way in to see the error, we will expedite the zooming process - press the left arrow and down arrow keys, to reduce the size of the zoom box, for focused zooming.
- (c) Place the zoom box on the curves, and where $x=\pi/2$, as in figure II.10 following:

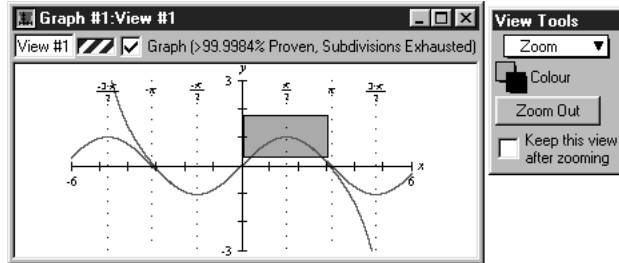

Figure II.10: Zoom box on the curves, and where $x=\pi/2$

- (d) When the zoom box covers the curves where $x=\pi/2$, press enter to zoom in. Repeat zooming until the two curves are visually separated.

Hint: The exact picture after zooming depends on where the zoom box is placed at each zoom; therefore, the pictures produced will most probably be a little different every time. Figure II.11 following will serve as an example only.

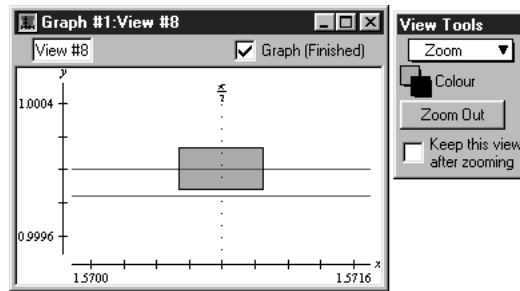

Figure II.11: Sine and McLaurin curves visually separated

3. Now we will read the amplitude of the error; using GrafEq's One Point view buddy to read the coordinates of the two curves at $\pi/2$, then calculate the difference in their y coordinates to get the error.

- (a) Return to the view buddy, and enter One Point mode by selecting One Point from the mode pop-up menu on the top of the floating window.
- (b) Place the mouse close to the desired point on the graph; pin down the point with the help of the magnified view on the view buddy.
- (c) Read the y -coordinate of the sine curve point from the view buddy, which is 1.0000024, as seen in figure II.12 following:

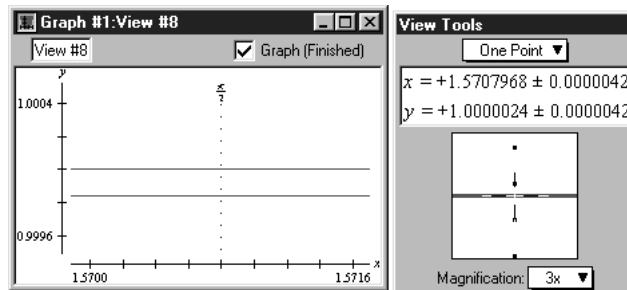

Figure II.12: One-point on sine curve reading 1.0000024

- (d) Read the y-coordinate of the McLaurin curve point from the view buddy, which is 0.9998400, as seen in figure II.13 following:

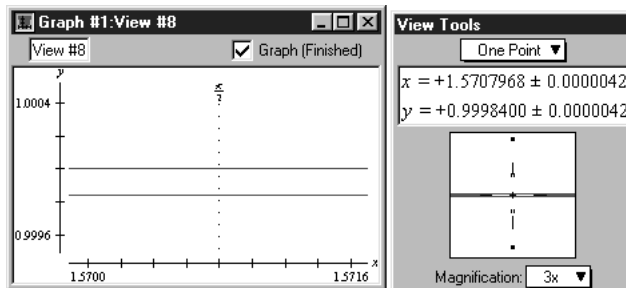

Figure II.13: *One-point on McLaurin curve reading 0.9998400*

- (e) The approximation error with a 4-term McLaurin polynomial is therefore: $1.0000024 - 0.9998400$, or 0.0001624 .
4. Repeat equivalent steps, as described above, for the 5-term McLaurin polynomial, and see that approximation error with a 5-term McLaurin polynomial is: $1.00000329 - 0.99999987$, or 0.00000342 .

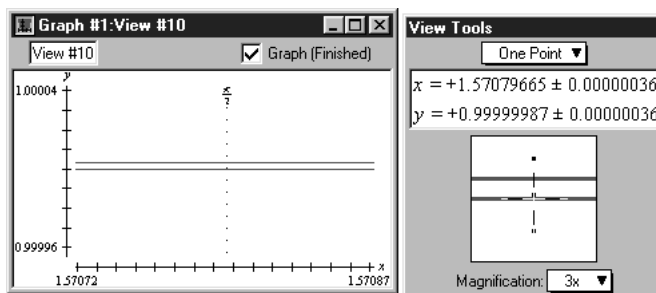

Figure II.14: *One-point on sine curve reading 0.99999987*

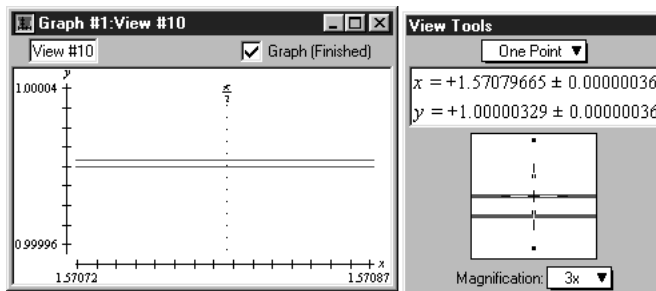

Figure II.15: *One-point on McLaurin curve reading 1.00000329*

CONCLUSIONS: In our exercise, we found that the 4-term McLaurin polynomial can approximate the sine function with a maximum error of 0.0001624 ; and the 5-term one, 0.00000342 .

Now, it has become clear that the question “How many terms would be close enough?” is rather vague. The best answer is perhaps: “How close is desired?”

Hint: Since the terms of the McLaurin series alternate between positive and negative, the approximation using n terms of the series has maximum error of the $(n+1)$ th term, once the terms are decreasing in magnitude. For x in $(0, \pi/2)$ this occurs immediately. Therefore, an alternative method for determining the number of terms required for some given accuracy, is to find the smallest n such that: $\frac{(\pi/2)^n}{n!} < \frac{1}{2}$ (desired accuracy)

Congratulations! You have completed this enrichment exercise. But if you like, feel free to try the following suggestions for further exercises:

- Discuss the differences among the different methods of reading the error of approximation - besides the one-point method described earlier, other GrafEq features can be used, such as the two-point method. From GrafEq's Two Point view buddy, drag points A and B respectively at the two curves and where $x=\pi/2$, as seen in figure II.16 following, then read the distance between the two points from the view buddy.

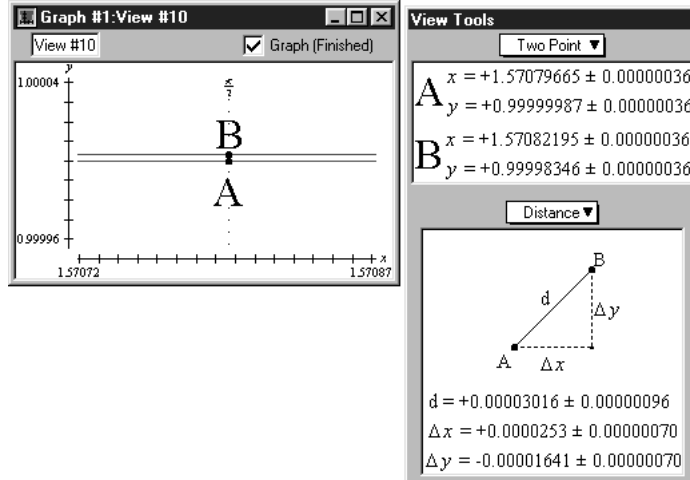

Figure II.16: Approximation error - two-point method

- Graphing the difference of the McLaurin polynomial approximation and the sine function is yet another method for determining the error. We open a new graph to investigate this method.

Hint: Before opening a new graph, it is good practice to close any current graphs which are not in use to free up the computer's memory and screen space. Just choose Close Graph from GrafEq's main File menu.

- Under the File menu select New Graph.
- Enter the error for 4-term McLaurin polynomial approximation as Relation #1, and the error for the 5-term McLaurin polynomial approximation as Relation #2, as seen in figure II.17 following:

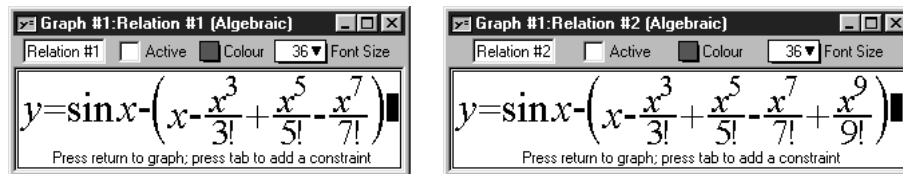
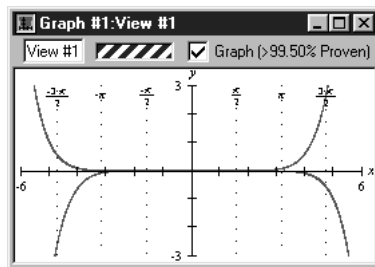
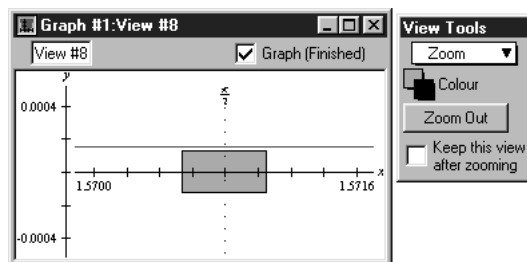

Figure II.17: Approximation error with 4-term and 5-term McLaurin polynomials

- The error graph should appear as follows:

Figure II.18: *Graph of the approximation errors*

- And if we zoom in, we can see that the approximation errors are different with the 4-term and 5-term McLaurin polynomials, as seen in figure II.19 following:

Figure II.19: *Graph of the approximation errors*

- Further, if we zoom in a few more times from figure II.19, we will also see that there is error with the 5-term McLaurin polynomial approximation too, as shown in figure II.20 following:

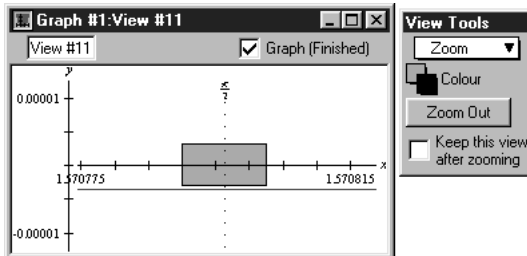
Figure II.20: *Graph of the approximation errors*

- Express $\sin 10$, $\sin(2\pi+1)$, and $\sin(-\pi)$ in terms of values between 0 and $\pi/2$.
- Prove that the error of McLaurin approximation for the sine curve increases as the magnitude of x increases.
- For a general description for the GrafEq program, visit the on-line description page at <http://www.peda.com/grafeq/>
- For an overview of the program's functionalities, visit the on-line specifications page at <http://www.peda.com/grafeq/>
- For a complete reference, consult the GrafEq manual.
- The appendices provide a useful summary and reference.
- This tutorial is based on GrafEq 2.04; users of other versions of GrafEq might need to adjust some steps for any differences in the user interface.

- While the steps shown in this tutorial are usually the most basic and intuitive ones, GrafEq can be operated with many powerful shortcut keys. Refer to the manual's appendix of shortcut keys for details.
- Many other features remain to be explored, such as:
 - copying and pasting relations and graphs,
 - making pages for printing,
 - saving graphs to disk,
 - using custom ticks,
 - using one-key short-cuts, and
 - customizing GrafEq for subsequent sessions.

Pedagoguery Software will be placing additional tours online at

<http://www.peda.com/grafeq/tutorials.html>,

and with the manual.

Index

Symbols

!, 73

Γ , 73

π , 72

θ , 72

A

absolute value, 75, 84

angle, 75

 binary function, 84

 determining, 30

arrows, 89

B

background colour, 24

blending

 relations, 24

boxes, 91

braces, 79

brackets, 79

C

cartesian, 13

case sensitive, 93

ceiling, 74, 84

circular trigonometry, 79, 85

clipboard, 47

 relations, 52

closed

 set, 94

closed set, 1

colour

 display, 2

 relation, 4, 10

 background, 24

 background default, 58

 custom ticks, 24, 32

 graphing speed, 66

 in formulae, 54

 relation, 24

 relation default, 58

 ticks, 24

colour buddy, 23

colours

 default, 58

commutative, 58

conditional definition, 79

conditional definitions, 85

constants

π , 93

e , 93

constraints, 4, 63

continuous

 set, 94

coordinates

 finding, 29

copy

 from screen to paper, 25

create view, 48

cube root, 71

curve riding, 29

custom ticks, 31

 creation, 48

 trig, 36

cut and paste, 47

 relations, 52

D

degrees, 86

diamond trigonometry, 79, 85

discontinuity, 65

discrete

 set, 94

distance

 determining, 30

division, 83

domain, 14

draw buddy, 28

drawing, 28, 87

 arrows, 89

 boxes, 91

 formulae, 89

 on pages, 41

 selected object, 87

 text, 90

 views, 41

E

e , 93

easy buttons, 7

 defaults, 53

EE, 23
 EEPS, 22
 extraneous solutions, 1

F

factorial, 73, 84
 files
 opening, 46
 saving, 46
 floor, 74, 84
 font
 size
 in algebraic window, 54
 fonts, 53
 size
 in algebraic window, 4
 in custom ticks, 34
 in custom ticks window, 32
 in structural window, 10
 in ticks, 27
 on page, 57
 startup naming, 54
 formulae, 89
 functions, 83
 in easy buttons, 69

G

gamma, 73, 84
 gcd, 73, 84
 graph
 creation, 13
 view, 17
 graph paper, 25
 graphing
 arithmetic, 60
 bounds, 56
 memory used, 22
 percentage done, 18
 speed, 22
 stages, 18
 symbolic pre-processing, 63
 technique, 64
 uncertain areas, 23
 greatest common divisor, 73, 84
 Greek letters, 73, 93
 greek letters
 fonts, 54

H

hyperbolic trigonometry, 79, 85

I

if, 79
 inequalities, 85
 infinity, 93

infix, 71
 information buddy, 22

K

KEE, 23
 KEEPS, 22
 keyboard shortcuts, 97

L

lcm, 73, 84
 least common multiple, 73, 84
 lg, 83
 ln, 70, 83
 log, 70, 83

M

magnifier, 29
 max, 76, 84
 maximum, 76, 84
 MEE, 23
 MEEPS, 22
 membership, 79
 memory, 66
 used for graphing, 22
 min, 76, 84
 minimum, 76, 84
 minutes, 86
 mod, 73, 84
 modulo, 73, 84

O

one point buddy, 29
 open
 set, 94
 open set, 1
 operators
 commutative, 58
 outlined
 ticks, 26

P

page window, 39
 flashing, 57
 parentheses, 79
 pattern
 relation default, 59
 pi, 72, 93
 polar, 13
 precedence, 9
 precision exhausted, 64
 preferences, 47, 51
 password, 57
 prefix, 71
 printing
 font size, 57

page buddy floating window, 41
page window, 39

R

range, 14

relation

conditional definition, 63
explicit, 63
implicit, 63
multiple constraints, 5
piecewise definition, 63
set notation, 63
structure, 9

relation window

algebraic, 3
structural, 9

relations, 83

fonts used, 53

Roman letters, 77, 93

root, 71, 72

round, 75, 84

S

seconds, 86

sets, 79, 85, 94

shortcuts, 97

signum, 75, 84

slope

determining, 30

speed, 66

square root, 70, 72

square trigonometry, 79, 85

subdivision exhausted, 64

T

text, 90

theta, 72

ticks

colour, 24

custom, 31, 48

customizing, 24

defaults, 60

outlined, 26

ticks buddy, 24

trig

custom ticks, 36

trigonometry, 79

circular, 79, 85

diamond, 79, 85

hyperbolic, 79, 85

inverse functions, 85

inverse relations, 85

square, 79, 85

trunc, 75, 84

tutorials, 101, 113

two point buddy, 29

V

values, 93

variables, 93

view, 17

creation, 13, 48

preserve aspect ratio, 15

size, 15, 56

use colour, 15, 58

view buddy, 21

colour, 23

draw, 28

information, 22

one point, 29

ticks, 24

two point, 29

zoom, 27

Z

zoom buddy, 27

zooming, 27, 60

